

ETIC

MADE IN ITALY. MADE TO EXCEL.



 atlas concorde

November 2017



WOOD LOOK  
**ETIC**  
Porcelain tiles

# Index

Overview



Spaces

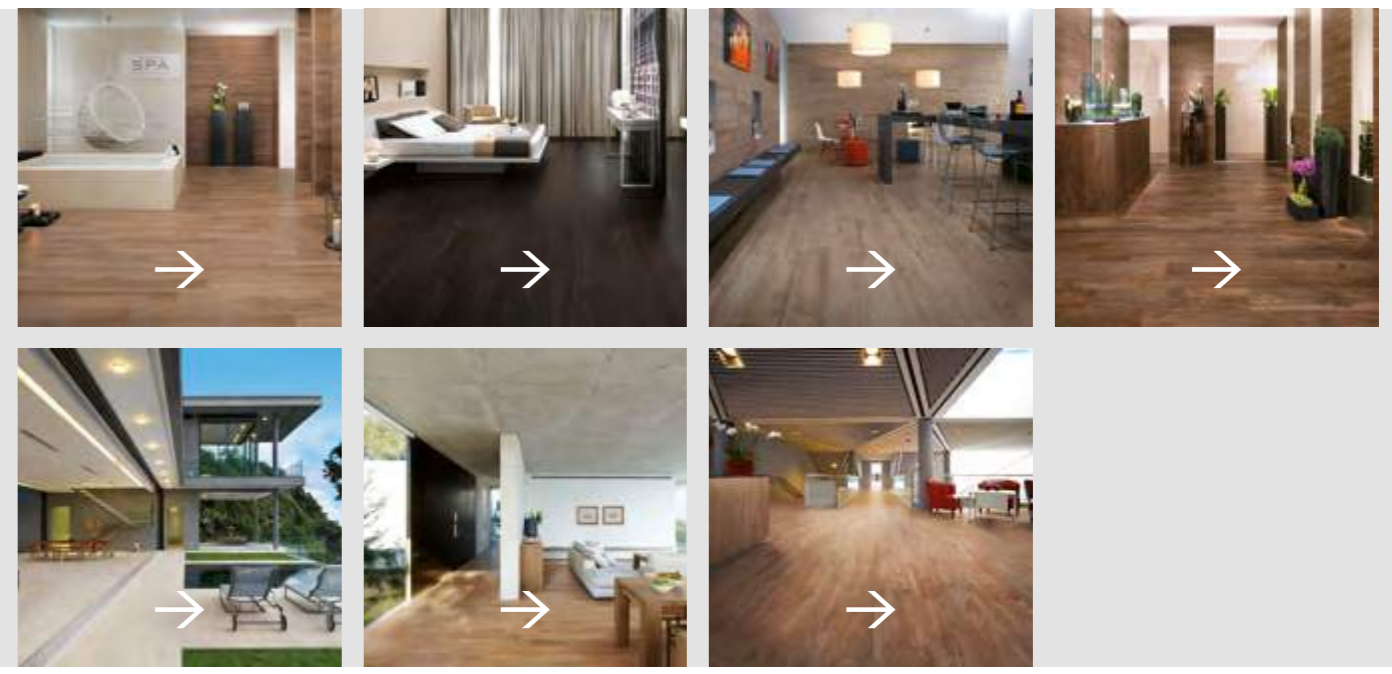

Product Range



Technical Specifications





# ETIC

WOOD-LOOK SURFACE RICH IN NATURAL SUGGESTIONS AND AUTHENTICITY.

The intense sensations of naturalness and authenticity of natural wood essences are brought to life on a porcelain ceramic surface that conveys the timeless charm of the natural material to contemporary spaces of refined design.

EFFETTO LEGNO RICCO DI SUGGERZIONI NATURALI E AUTENTICITÀ.

Le intense sensazioni di naturalezza e autenticità di essenze legno non trattate rivivono sulla superficie di un gres porcellanato che porta il fascino intramontabile della materia d'ispirazione in ambienti contemporanei dal design raffinato.

Imitation bois riche en suggestions naturelles et authenticité.

Les intenses sensations de naturel et d'authenticité des essences de bois non traitées revivent sur la surface d'un grès cérame qui apporte le charme éternel de la matière d'inspiration dans des espaces contemporains au design raffiné.

Efecto madera rico de sugerstiones naturales y autenticidad.

Las intensas sensaciones de naturalidad y autenticidad de las maderas no tratadas reviven en una superficie en gres porcelánico que lleva el encanto imperecedero del material de inspiración a ambientes de diseño elegante.

Außergewöhnliche natürliche und authentische Holzoptik.

Die intensiven Empfindungen der Natürlichkeit und der Originalität von unbehandelten Holzarten leben auf der Oberfläche eines Feinsteinzeugs, das den zeitlosen Charme des Materials der Vorlage in zeitgenössische Ambiente in stilvollem Design trägt, wieder auf.

Глубокий и натуральный рисунок дерева.

Насыщенная красота необработанной древесины оживает в керамогранитной поверхности, которая приносит в современные пространства естественную красоту природного материала.



Palissandro

Noce

Rovere

Atlas Concorde — Etic

## Etic ESSENCES

### PRECIOUS WOOD ESSENCES RICH IN FASCINATION AND HISTORY.

Etic offers a careful selection of seven precious wood essences, each characterized by history, appeal and fascination making the surface unique and unrepeatable.

### PREGIATE ESSENZE LEGNO RICCHE DI FASCINO E STORIA.

Etic propone un'accuratissima selezione di sette pregiate essenze legno, ognuna caratterizzata da storia, estetica e fascino propri, che le rendono uniche e irripetibili.

Ulivo

Ebano

Rovere Grigio

**PORCELAIN TILE SURFACES EVOKE DIFFERENT NATURAL WOOD ESSENCES FOR COMPOSITIONS OF MARKED PERSONALITY.**  
SUPERFICI IN GRES PORCELLANATO EVOCANO ESSENZE LEGNO DI DIVERSA ISPIRAZIONE PER COMPOSIZIONI RICCHE DI PERSONALITÀ.

*Des surfaces en grès cérame évoquent des essences de bois de différente inspiration pour des compositions riches en personnalité. Oberflächen aus Feinsteinzeug bilden die Optik verschiedener Holzarten nach und sorgen für Kompositionen voller Persönlichkeit. Superficies en gres porcelánico evocan maderas de diversa inspiración para crear composiciones de marcada personalidad. Керамогранитные плитки воспроизводят рисунок разных пород древесины и складываются в богатые композиции.*

Rovere Bianco

De précieuses essences de bois riches en charme et en histoire. Etic propose une sélection minutieuse de sept précieuses essences de bois, chacune caractérisée par son histoire, son esthétique et son charme, qui les rendent uniques et exclusives.

Edle Holzarten voller Charme und Geschichte. Etic bietet eine sorgfältige Auswahl von sieben edlen Holzarten, die jeweils über ihre eigene Geschichte, Schönheit und Charme verfügen, die sie einzigartig und unwiederholbar machen.

Valiosas maderas llenas de encanto e historia. Etic propone una atenta selección de siete valiosas maderas, cada una de ellas con una historia, estética y encanto personales, lo que las hace ser únicas e irrepetibles.

Изысканная и благородная фактура дерева. Etic предлагает имитацию семи ценных пород древесины, у каждой из которых своя история и своя эстетика. Поэтому каждая линейка плитки уникальна и неповторима.



## Etic SURFACES

### PERFECT VISUAL CONTINUITY BETWEEN THE INDOORS AND OUTDOORS.

Etic offers two surface finishes to give life to continuous indoor and outdoor spaces. The matte finish, characterized by a natural appeal with a soft touch and micro-textures that evoke age-old wood essences, is combined with the textured surface for outdoor applications that reproduces the saw cut finish with an alluring three-dimensional effect.

### PERFETTA CONTINUITÀ VISIVA TRA INTERNI ED ESTERNI.

Etic propone due finiture di superficie per dare vita a spazi in cui dentro e fuori dialogano in totale continuità visiva. La superficie matt, caratterizzata da un'estetica naturale dalla mano morbida e da microstrutture che evocano legni dal fascino leggermente vissuto, è affiancata dalla versione strutturata per esterni che riproduce una lavorazione piano sega dal suggestivo effetto tridimensionale.

#### Une parfaite continuité visuelle entre les espaces intérieurs et extérieurs.

Etic propose deux finitions de surfaces pour créer des espaces où l'intérieur et l'extérieur communiquent dans une parfaite continuité visuelle. La surface mate, caractérisée par une esthétique naturelle au doux toucher et par des microstructures qui évoquent des bois au charme légèrement vécu, est juxtaposée à la version structurée pour extérieurs qui reproduit un usinage de sciage à l'effet suggestif et tridimensionnel.

#### Perfekte optische Kontinuität von Innen- und Außenbereichen.

Etic wird mit zwei Oberflächenfinishs angeboten, um Räume zu gestalten, in denen die Innen- und Außenbereiche in optischer Kontinuität miteinander in Dialog treten. Die matte Oberfläche, gekennzeichnet durch natürliche und sanfte Ästhetik mit Mikrostrukturen, die an den Charme von leicht abgenutztem Holz erinnert, wird ergänzt von der strukturierten Version mit einer Optik von gesägtem Holz und einer auffallenden dreidimensionalen Wirkung für Außenbereiche.

#### Perfecta continuidad visual entre interiores y exteriores.

Etic propone dos acabados de superficie para dar vida a espacios en que los interiores y exteriores establecen un diálogo en una total continuidad visual. La superficie opaca, caracterizada por un aspecto natural de mano suave y por microestructuras que evocan maderas de encanto levemente desgastado es presentada junto a la versión estructurada para exteriores que reproduce la elaboración sierra corte plano de sugerente efecto tridimensional.

#### Гармония внутренних и наружных пространств.

У плиток Etic два варианта поверхности, благодаря которым внутренние и наружные пространства можно оформить в едином стиле. Матовые плитки с мягкой микроструктурой напоминают слегка состаренное дерево. Структурные плитки для уличной укладки воспроизводят эффектную трехмерную фактуру пиленной древесины.



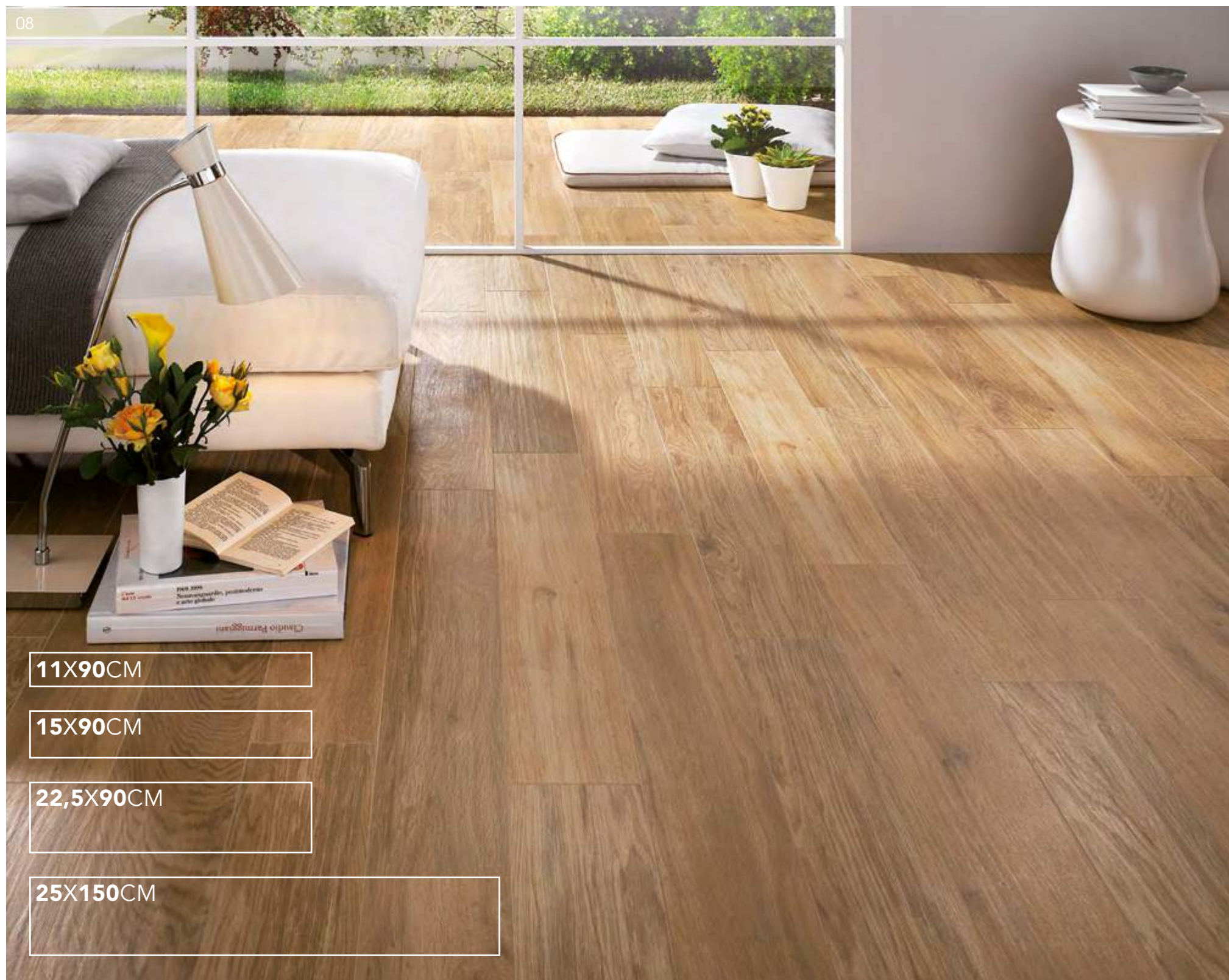

11X90CM

15X90CM

22,5X90CM

25X150CM

## MATTE finish

**THE MATTE FINISH IS CHARACTERIZED BY A MICRO-TEXTURE EVOKING FLOORS IN NATURAL AGE-OLD WOOD. AVAILABLE IN DIFFERENT SIZES OF 90 CM LENGTH AND IN SIZE 25X150 CM.**

LA FINITURA MATT È CARATTERIZZATA DA UNA MICRO-STRUTTURA CHE SI ISPIRA AI PAVIMENTI IN LEGNO NATURALE NON TRATTATO E LEGGERMENTE USURATO. DISPONIBILE IN DIVERSI FORMATI DI LUNGHEZZA 90 CM E NEL FORMATO 25X150 CM.

*La finition mate est caractérisée par une microstructure qui s'inspire aux sols en bois naturel non traité et légèrement usé. Disponible en différents formats de 90 cm de longueur et au format 25x150 cm. Die matte Oberfläche kennzeichnet sich durch eine Mikrostruktur, die von unbehandelten und etwas abgenutzten Naturholzböden inspiriert ist. Erhältlich in verschiedenen Größen in der Länge von 90 cm und im Format 25x150 cm. El acabado opaco se caracteriza por una micro-estructura que se inspira en los pavimentos en madera natural no tratada y levemente desgastada. Disponible en diversos formatos de 90 cm de largo y en el formato 25x150 cm. Матовые плитки характеризуются мягкой микроструктурой, такой же, как у слегка состаренных полов из натурального дерева. Доступны в разных форматах длиной 90 см и в формате 25x150 см.*

## TEXTURED finish

**THE TEXTURED SURFACE COMBINES THE LOOK OF WOOD WITH THE ADVANTAGES OF PORCELAIN TILES: SAFE, ANTI-SLIP, RESISTANT TO FROST, THERMAL SHOCK AND ADVERSE WEATHER. IT IS SUITABLE FOR INDOOR AND OUTDOOR SPACES REQUIRING SPECIFIC TECHNICAL PERFORMANCE.**

LO STRUTTURATO UNISCE L'ESTETICA DEL LEGNO AI VANTAGGI DEL GRES PORCELLANATO: SICURO, ANTISCIVOLO, INGELIVO, RESISTENTE A SBALZI TERMICI E AD AGENTI ATMOSFERICI. È IDEALE IN ESTERNI E IN INTERNI CHE NECESSITANO SPECIFICHE PRESTAZIONI TECNICHE.



22,5X90CM

*L'effet structuré unit l'esthétique du bois aux avantages du grès cérame : sûr, résistant au gel, aux écarts de température et aux agents atmosphériques. Il est idéal pour les extérieurs et les intérieurs qui exigent des prestations techniques spécifiques. Bei der strukturierten Oberfläche verbindet sich die Ästhetik des Holzes mit den vorteilhaften Eigenschaften von Feinsteinzeug (frostsicher, rutschfest, temperaturwechsel- und witterungsbeständig). Ideal für Innen- und Außenbereiche, die besondere technische Eigenschaften benötigen. El estructurado une la estética de la madera a las ventajas del gres porcelánico: seguridad, propiedades antideslizamiento, resistente al hielo, a los cambios bruscos de temperatura y a los agentes atmosféricos. Es ideal en exteriores e interiores que requieren prestaciones técnicas específicas. Структурные плитки сочетают фактуру дерева с преимуществами керамогранита – безопасностью, сопротивлением скольжению, стойкостью к морозам, температурным перепадам, атмосферным воздействиям. Идеальны для укладки на улице и в интерьерах, требующих от покрытий высоких эксплуатационных показателей.*



atlas concorde

## Spa&Beauty Club, London

Etic Essences: Noce 22,5x90, Noce Strutturato 22,5x90, Noce Tatami 22,5x90  
 Matching Surfaces: Advance Bianco Brera 45x90  
 Floor installation: Straightforward installation

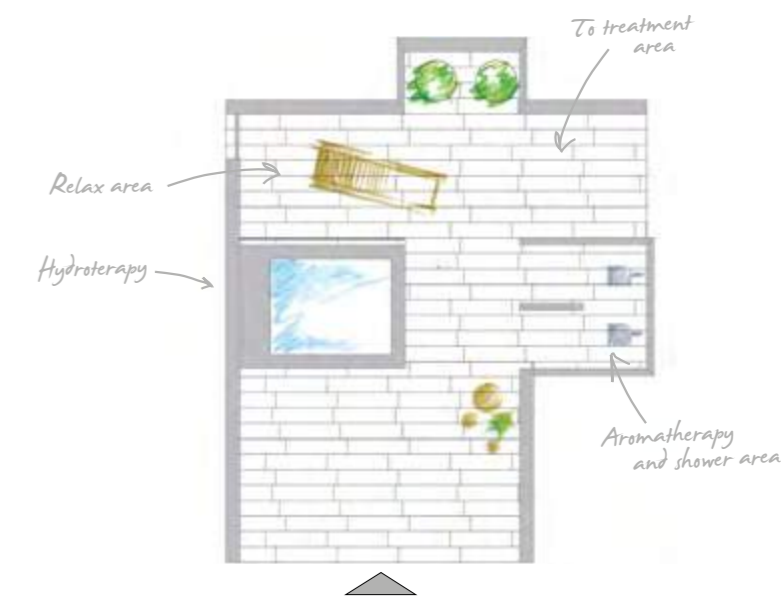

### Natural sensations of well-being

The sophisticated essence of Noce, with its long waving veining and soft knots, recreates a welcoming and evocative space in which to experience a regenerating “cocooning” effect. The merger between the naturalness of wood and technology of ceramics makes Etic the perfect finishing touch for projects dedicated to welcoming and wellness, and in every context where functionality and safety are required.

#### Les sensations d'un bien-être naturel.

Avec son long veinage ondulé et la douceur de ses nœuds, Noce est une essence sophistiquée permettant de composer un espace accueillant et suggestif où un agréable effet « cocooning » permet de se retremper. Le mariage entre le naturel du bois et la technologie de la céramique font d'Etic la finition idéale dans les projets dédiés à l'accueil et au bien-être, ainsi que dans tous les contextes qui exigent des rendements de praticité et de sécurité.

#### Empfindungen natürlichen Wohlbefindens.

Die raffinierte Essenz Noce mit ihren langen geschwungenen Äderungen und den weichen Knoten schafft ein behagliches und stimmungsvolles Ambiente, in dem man sich nur zu gerne dem angenehmen regenerierenden Effekt des “cocooning” hingeben möchte. Die Verbindung der Natürlichkeit des Holzes und der Technologie der Keramik macht Etic zum idealen Finish für Projekte im Empfangsbereich und des Wohlbefindens und überhaupt in allen Kontexten, in denen Leistungen wie Zweckmäßigkeit und Sicherheit gefragt sind.

### Sensazioni di naturale benessere

La sofisticata essenza Noce, con le sue lunghe vene ondulate e i nodi morbidi, ricrea un ambiente accogliente e suggestivo dove rigenerarsi con un piacevole effetto “cocooning”. Il connubio tra la naturalezza del legno e la tecnologia della ceramica rende Etic una finitura ideale per progetti dedicati all'accoglienza e al benessere, e in tutti i contesti in cui si richiedono prestazioni di praticità e sicurezza.

#### Sensaciones de bienestar natural.

La sofisticada madera Noce, con sus largas venas onduladas y los nudos suaves, recrea un ambiente acogedor y suggestivo en donde regenerarse con un placentero efecto “cocooning”. La unión entre la naturaleza de la madera y la tecnología de la cerámica hace de Etic un acabado ideal para proyectos dedicados a la acogida y al bienestar, y para todos los contextos en los que es necesaria la practicidad y la seguridad.

#### Ощущение натуральности и комфорта.

Изысканная ореховая фактура Ноце своими длинными волнистыми прожилками и мягкими узелками рождает уютную атмосферу, в которой так приятно нежиться. А симбиоз натурального вида дерева и прочности керамогранита делают коллекцию идеальной для оформления курортных интерьеров, велнес-пространств и всех тех контекстов, где требуются практичные материалы с высокими показателями безопасности.

# Spa&Beauty Club, London

Etic Essences: Noce 22,5x90, Noce Strutturato 22,5x90,  
 Noce Tatami 22,5x90  
 Matching Surfaces: Advance Bianco Brera 45x90  
 Floor installation: Straightforward installation

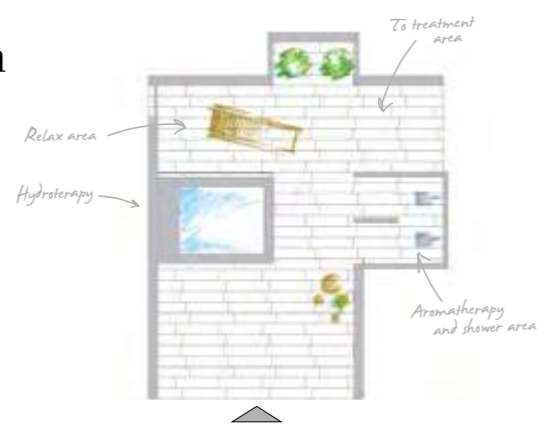

INDEX

OVERVIEW

SPACES

RANGE

TECH. SPECS



# Spa&Beauty Club, London

Etic Essences: Noce 22,5x90, Noce Strutturato 22,5x90,  
Noce Tatami 22,5x90  
Matching Surfaces: Advance Bianco Brera 45x90  
Floor installation: Straightforward installation

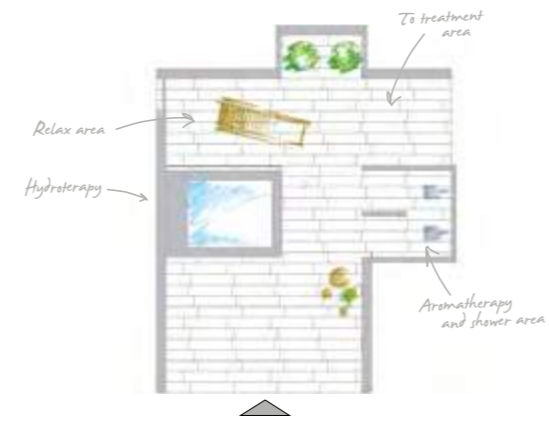



atlas concorde

## Hotel suite, Madrid

Etic Essences: Ebano 22,5x90

Matching Surfaces: Advance Bianco Brera 45x90,

Advance Bianco Brera Mosaico 30x30

Floor installation: Straightforward installation

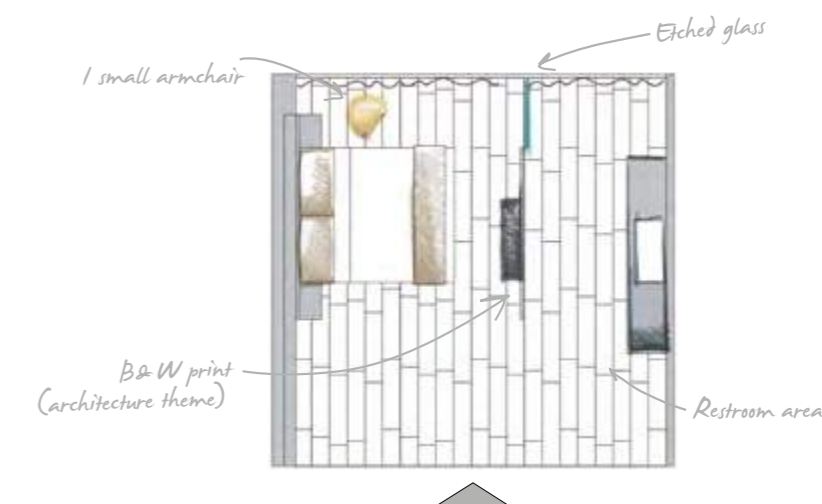

### Nature that enchants and welcomes

Used in hospitality venues, Etic expresses a suggestive and welcoming atmosphere via the sensations evoked by Ebano, a faithful reproduction of the charming attraction of African wood, renowned for its rich colour crossed by long veining and distinct knots. Its intense tints combine with brilliant and luminous materials in a natural play of bright and dark light.

#### La nature enchante et accueille.

Dans les espaces consacrés à l'hospitalité, Etic exprime une beauté suggestive et accueillante, soulignée par les sensations que dégage Ebano, une finition qui reproduit fidèlement le magnétisme d'une essence africaine caractérisée par sa couleur intense, ses longues veines et ses nœuds résolus. Ses teintes profondes se marient aux matières claires et lumineuses dans un jeu naturel d'ombres et de lumière.

#### Natur, die verzaubert und einhüllt.

In Ambienten, die dem Gastgewerbe gewidmet sind, weist Etic eine bezaubernde und einnehmende Ästhetik auf und betont Gefühle und Eindrücke, die durch Ebano hervorgerufen werden. Das Finish, welches naturgetreu den anziehenden Charakter von afrikanischem Holz wiedergibt, charakterisiert auch durch die intensive Farbe, ist gekennzeichnet durch lange Äderungen und deutliche Knoten. Die beiden Töne verbinden sich in einem ganz natürlichen Spiel von Hell und Dunkel hervorragend mit klaren und hellen Materialien.

### Natura che incanta e accoglie

Negli ambienti dedicati all'ospitalità, Etic esprime un'estetica suggestiva e accogliente enfatizzata dalle sensazioni evocate dall'Ebano, finitura che riproduce fedelmente il carattere magnetico del legno africano, contraddistinto da un colore intenso, solcato da lunghe venature e nodi decisi. Le sue tinte profonde si sposano con materie chiare e luminose in un gioco di chiaro scuro tutto naturale.

#### Naturaleza que encanta y acoge.

En los ambientes dedicados a la hospitalidad, Etic es la expresión de una estética sugestiva y acogedora enfatizada por las sensaciones evocadas por el Ebano, acabado que reproduce fielmente el fascinante carácter de esta madera africana, que se distingue por un color intenso, surcado por largas vetas y nudos marcados. Sus tonalidades profundas se combinan bien con materiales claros y luminosos en un juego de claroscuros totalmente natural.

#### Чарующая и радушная природа.

В интерьерах отельных комплексов изысканная и радушная обстановка, создаваемая коллекцией Etic, подчёркивается эффектной фактурой Ebano, точно воспроизводящей чарующий вид африканского эбенового дерева с его насыщенными цветами, длинными прожилками и ярко выраженными узлами. Тёмные глубокие оттенки соседствуют в гармоничном контрасте со светлыми, даря пленительное ощущение натуральности.

### Hotel suite, Madrid

Etic Essences: Ebano 22,5x90  
Matching Surfaces: Advance Bianco Brera 45x90,  
Advance Bianco Brera Mosaico 30x30  
Floor installation: Straightforward installation

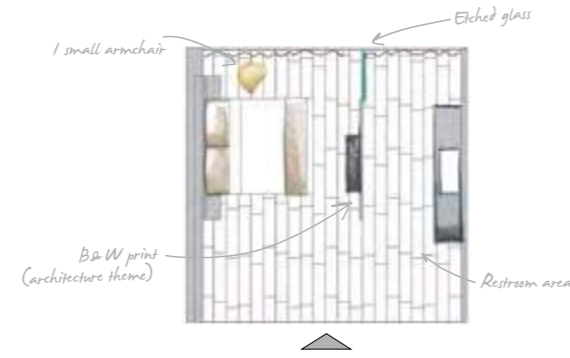

INDEX

OVERVIEW

SPACES

RANGE

TECH. SPECS

### Hotel suite, Madrid

Etic Essences: Ebano 22,5x90  
Matching Surfaces: Advance Bianco Brera 45x90,  
Advance Bianco Brera Mosaico 30x30  
Floor installation: Straightforward installation

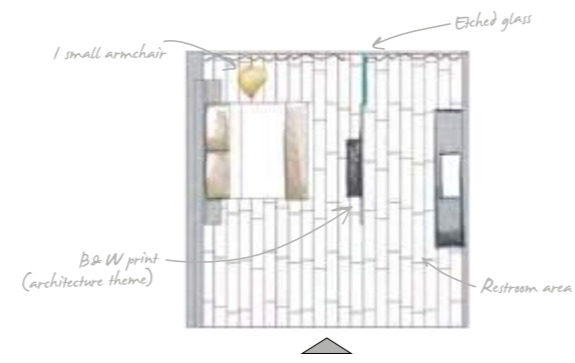



atlas concorde

## Art Cafè, Basel

Etic Essences: Rovere Grigio 22,5x90

Matching Surfaces: Plenitude White Orchid 30,5x91,5

Floor installation: Straightforward installation

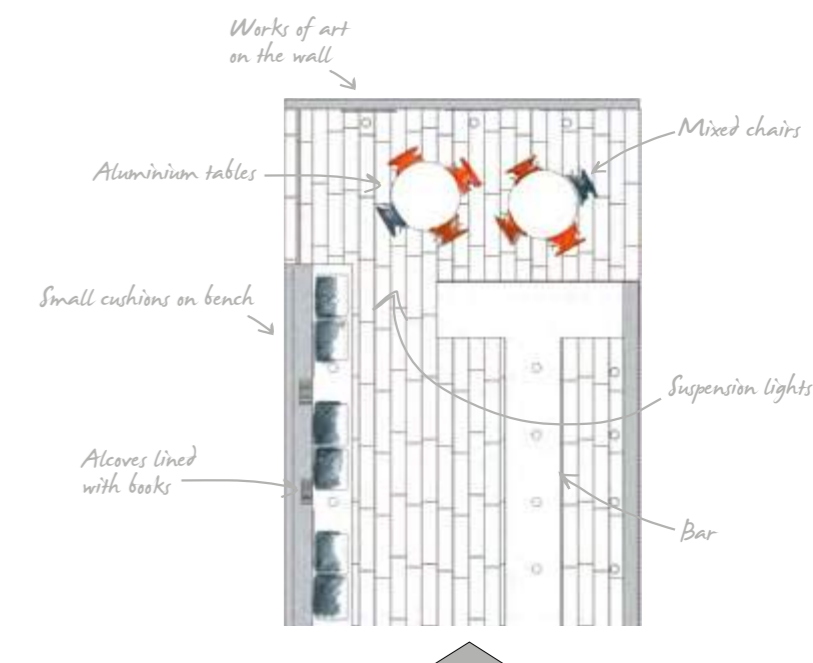

### Architecture as a piece of art

The most up-to-date and trend-setting architectural spaces rediscover the enduring value of Rovere Grigio, inspired by an essence that owes its fascination to a natural ageing process that enriches it with an unmistakable, emotional hue. The 22.5x90 size wood listels, with a straightforward installation in a coordinated project of floor and wall covering, creates a welcoming ambience rich in style and personality.

#### L'architecture est une œuvre d'art.

En architecture, les espaces de tendance les plus actuels redécouvrent la valeur inaltérable de Rovere Grigio, inspiré d'une essence qui doit son charme au processus de vieillissement naturel qui lui donne une couleur incomparable, richement suggestive. Posées en longueur dans un projet coordonné au sol et aux murs, les lattes de format 22,5x90 composent un espace accueillant, riche de style et de personnalité.

#### Architektur als Kunstwerk.

Die aktuellsten und trendigsten architektonischen Räume entdecken den zeitlosen Wert von Rovere Grigio wieder, inspiriert durch eine Holzessenz, die ihren Charme einem natürlichen Alterungsprozesses mit einer unverwechselbaren Farbgebung verdankt, reich an Empfindungen und Eindrücken. Das Format der Dielen 22,5x90, fortlaufend in einem aufeinander abgestimmten Projekt für Böden und Wände verlegt, erzeugt ein gemütliches Ambiente, stilvoll und voller Persönlichkeit.

### Architetture come opere d'arte

Gli spazi architettonici più attuali e di tendenza riscoprono il valore intramontabile del Rovere Grigio, ispirato a un'essenza che deve il suo fascino a un processo di invecchiamento naturale, che le dona una cromia inconfondibile ricca di suggestioni. Il formato delle doghe 22,5x90, posato a corere in un progetto coordinato a pavimento e rivestimento, crea un ambiente accogliente ricco di stile e personalità.

#### Arquitecturas como obras de arte.

Los espacios arquitectónicos más actuales y de tendencia redescubren el valor imperecedero del Rovere Grigio, inspirado en una madera que debe su encanto a un proceso de envejecimiento natural, que le da una tonalidad inconfundible rica de sugerencias. El formato de las tablas 22,5x90, con colocación simple en un proyecto coordinado de pavimento y revestimiento, crea un ambiente acogedor rico de estilo y personalidad.

#### Архитектурные формы как произведения искусства.

Современные архитектурные формы, облачаясь в тон Rovere Grigio, снова открывают для себя непреходящее благородство дубового дерева. Очаровательная фактура плиток напоминает естественно состарившуюся древесину дуба с её характерным, изысканным цветом. Уложенный вразбегу на полы и стены формат 22,5x90 придаёт интерьеру стильность и своеобразие, рождая при этом удивительно гостеприимную обстановку.

# Art Cafè, Basel

Etic Essences: Rovere Grigio 22,5x90  
Matching Surfaces: Plenitude White Orchid 30,5x91,5  
Floor installation: Straightforward installation

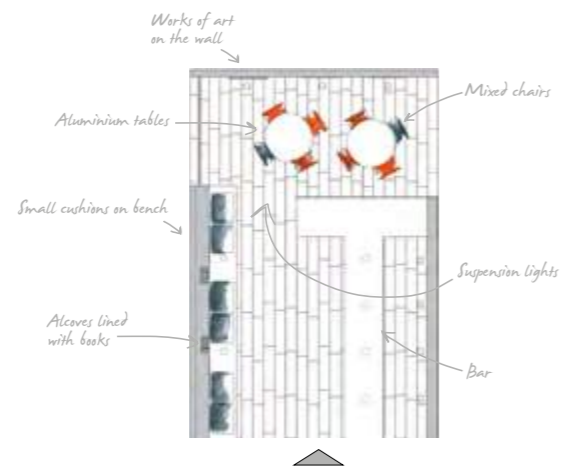

atlas concorde



atlas concorde

INDEX

OVERVIEW

SPACES

RANGE

TECH. SPECS

### ■ Art Cafè, Basel

Etic Essences: Rovere Grigio 22,5x90  
Matching Surfaces: Plenitude White Orchid 30,5x91,5  
Floor installation: Straightforward installation

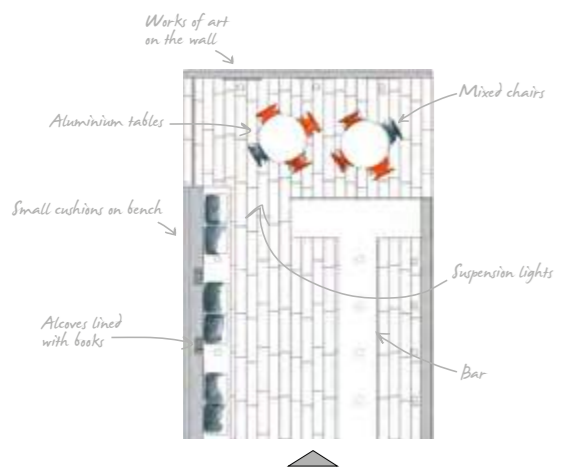

INDEX

OVERVIEW

SPACES

RANGE

TECH. SPECS

atlas concorde

## Floral showroom, Milan

Etic Essences: Palissandro 22,5x90 / 15x90, Palissandro Tatami 22,5x90

Matching Surfaces: Advance Moca Creme 45x90

Floor installation: Straightforward installation

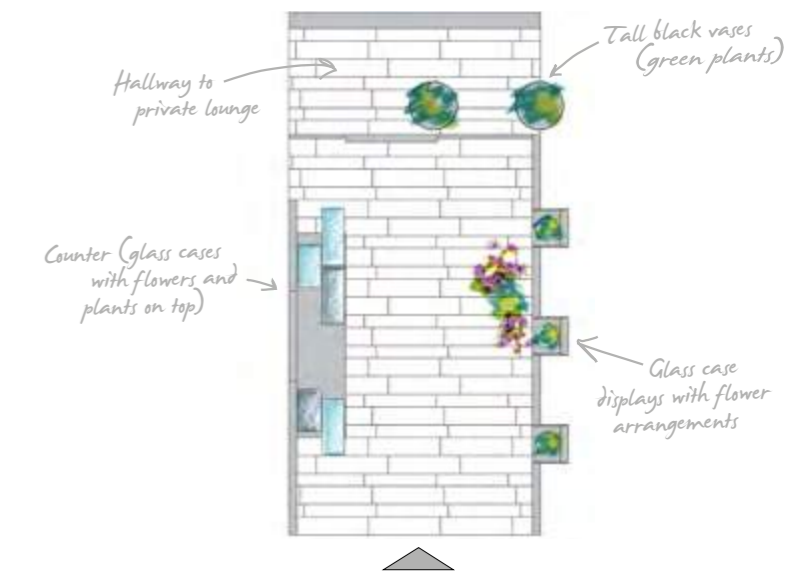

### Decorations of sophisticated essentiality

The bold character of Palissandro, an exotic essence with a brown shade enriched by dark streaks, bestows elegance and charm to commercial spaces of refined design. Etic features three different sizes, all with a 90 cm length, which reproduce the listels characteristic of parquet wood for flooring and may be played off against each other through different installation patterns. Sophisticated and versatile, the Tatami mosaic thin listels break down the graphic look of its surface, enhancing panel partitioning and walls.

#### Des décorations d'une essentialité sophistiquée.

Le caractère résolu de Palissandro, cette essence exotique aux tons bruns, enrichies de veinures foncées, donne de l'élégance et du charme aux espaces commerciaux d'un design raffiné. Etic propose trois formats différents de 90 cm de base qui reproduisent les lattes de bois traditionnellement utilisées pour les sols et peuvent se combiner entre elles en différents jeux de pose. Élégante et versatile, la mosaïque Tatami décompose le motif de la surface en fins listels qui rehaussent les murets et les murs.

#### Dekore von raffinierter Sachlichkeit.

Der hervortretende Charakter von Palissandro, einer exotischen Essenz in bräunlicher Farbe, bereichert durch dunkle Streifen, verleiht Industrieambientes in raffiniertem Design Eleganz und Charme. Etic ist, auf Basis von 90 cm Länge, in drei unterschiedlichen Breiten verfügbar, die den typischen Holzdielen für Fußböden nachempfunden sind und untereinander in verschiedenen Verlegearten verwendet werden können. Elegant und vielseitig bringt das Mosaik Tatami mit seinen dünnen Leisten die Grafik der Oberfläche durcheinander und betont dadurch Kulissen und Wände.

### Decorazioni di sofisticata essenzialità

Il carattere deciso del Palissandro, essenza esotica dalla tonalità bruna arricchita da striature scure, conferisce eleganza e fascino ad ambienti commerciali dal design raffinato. Etic propone tre diversi formati su base di 90 cm, che ripropongono le tipiche doghe del legno da pavimento e possono essere accostate tra loro in differenti giochi di posa. Elegante e versatile, il mosaico Tatami scompone in sottili listelli la grafica di superficie valorizzando quinte e pareti.

#### Decoraciones de sofisticada esencialidad.

El carácter decidido del Palissandro, madera exótica estriada y de tonalidad oscura, confiere elegancia y encanto a ambientes comerciales de diseño refinado. Etic propone tres diferentes formatos sobre base de 90 cm, que reproducen las típicas tablas de madera para pavimento y pueden ser combinadas entre sí en diferentes juegos de colocación. Elegante y versátil, el mosaico Tatami descompone en sutiles listeles el diseño gráfico de superficie valorizando mamparas y paredes.

#### Изысканно-строгие декоры.

Решительный характер фактуры Palissandro, напоминающей экзотическое палисандровое дерево с его светло-коричневым фоновым цветом и узором из тёмных прожилок, придаёт коммерческим интерьерам пленительную элегантность. Etic предлагает три формата на основе модульной длины в 90 см: все они воспроизводят формы половых досок и могут сочетаться между собой в различных рисунках укладки. Элегантная, многофункциональная мозаика Tatami разлагает рисунок облицованной поверхности на тонкие бордюры, эффектно оттеняя нарядность стен и перегородок.



### Floral showroom, Milan

Etic Essences: Palissandro 22,5x90 / 15x90,  
Palissandro Tatami 22,5x90  
Matching Surfaces: Advance Moca Creme 45x90  
Floor installation: Straightforward installation

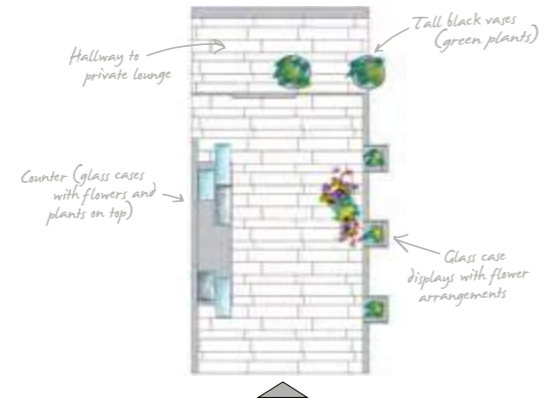

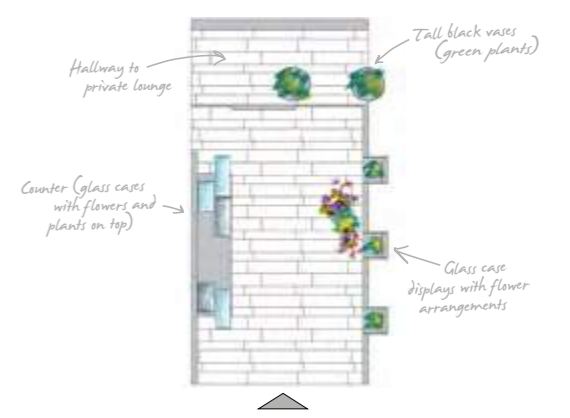

### Floral showroom, Milan

Etic Essences: Palissandro 22,5x90 / 15x90,  
 Palissandro Tatami 22,5x90  
 Matching Surfaces: Advance Moca Creme 45x90  
 Floor installation: Straightforward installation





atlas concorde

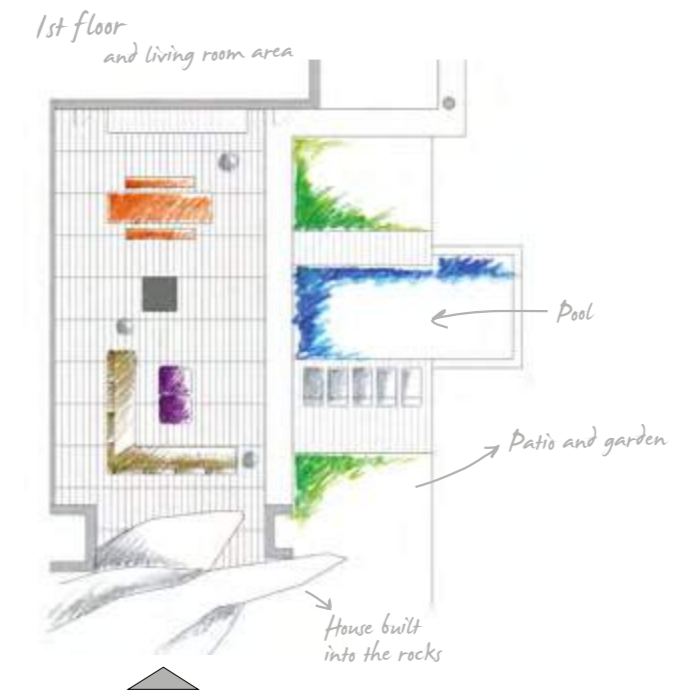

## ■ Private villa, Perth

Rovere Bianco 22,5x90, Rovere Bianco Strutturato 22,5x90  
 Rovere Bianco Elemento L Strutturato 22,5x90,  
 Noce 11x90, Noce Strutturato 22,5x90  
 Linear installation

### Top performance applications

The natural whiteness of Rovere Bianco gives spaces an essential and soft touch, both indoors and outdoors, where the textured surface is completed by the L element, a prerequisite for finishing off steps and swimming-pool edges. Etic brings the glamour of wood into those contexts that are traditionally shut off from natural materials, thanks to its high technical features.

### Applicazioni ad elevate prestazioni

Il candore naturale del Rovere Bianco conferisce agli ambienti essenzialità e luce negli spazi interni come negli esterni, dove la superficie strutturata si completa con l'elemento L, indispensabile per rifinire gradini e bordi piscina. Etic porta il fascino del legno nei contesti preclusi alla materia naturale, grazie a elevate performance tecniche.

### Private Villa, Perth

Etic Essences: Rovere Bianco 22,5x90, Rovere Bianco Strutturato 22,5x90  
Rovere Bianco Elemento L Strutturato 22,5x90  
Floor installation: Linear installation

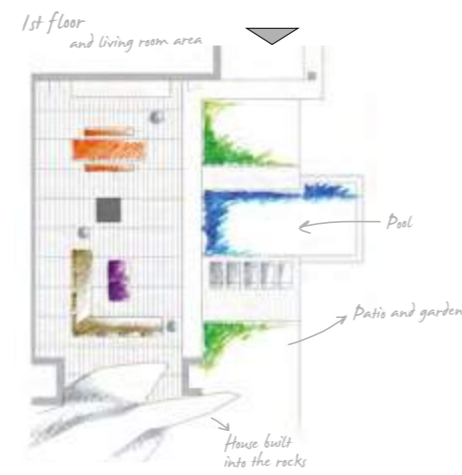

atlasconcorde



atlasconcorde



INDEX

OVERVIEW

SPACES

RANGE

TECH. SPECS



## Private Villa, Perth

Etic Essences: Rovere Bianco Strutturato 22,5x90, Rovere Bianco Elemento L Strutturato 22,5x90  
Floor installation: Linear installation

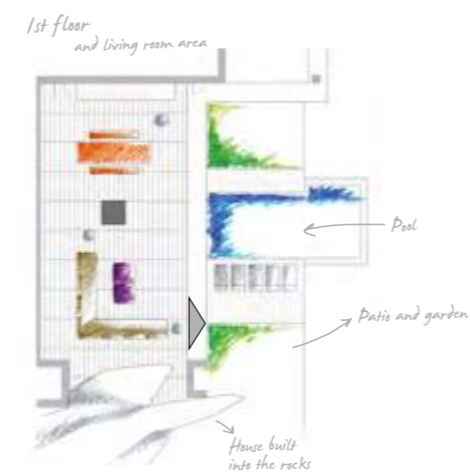

### Applications aux performances élevées.

La blancheur naturelle de Rovere Bianco apporte aux espaces de l'essentialité et de la lumière, tant à l'intérieur qu'à l'extérieur où la surface structurée est complétée par un élément en L, indispensable aux finitions des escaliers et des bords de piscine. Grâce à ses rendements techniques élevés, Etic apporte le charme du bois dans les contextes interdits aux matériaux naturels.

### Hohe Leistungen.

Die natürliche Reinheit von Rovere Bianco verleiht den Ambienten, innen wie außen, Sachlichkeit und Licht, wobei die Oberfläche strukturierte das Angebot mit dem L-Element, unentbehrlich für Treppen und Schwimmbadränder, vervollständigt. Etic trägt den Charme des Holzes in Kontexte, die natürlichen Materialien verwehrt sind und besticht durch die technische Leistung.

### Aplicaciones de elevadas prestaciones.

El candor natural del Rovere Bianco confiere a los ambientes esencialidad y luz tanto en los espacios interiores como en los exteriores, donde la superficie estructurada se completa con el elemento L, indispensable para acabar escalones y bordes de piscina. Etic lleva el encanto de la madera a los contextos en los que está excluido el empleo de la materia natural, gracias a sus elevadas características técnicas.

### Высокие эксплуатационные качества.

Натуральная, мягкая чистота дубовой фактуры Rovere Bianco придаёт интерьерам и экстерьерам благородную строгость и вместе с тем наполняет их тёплым светом. Для укладки на улице плитки со структурной поверхностью дополняются L-образными элементами, дающими возможность красиво оформить ступени и края бассейнов. Etic приносит с собой очарование древесного рисунка даже в те контексты, в которых применение самого дерева невозможно, обеспечивая при этом высочайшие эксплуатационные показатели.



# Private Villa, Perth

Etic Essences: Rovere Bianco 22,5x90, Rovere Bianco Strutturato 22,5x90  
Floor installation: Linear installation

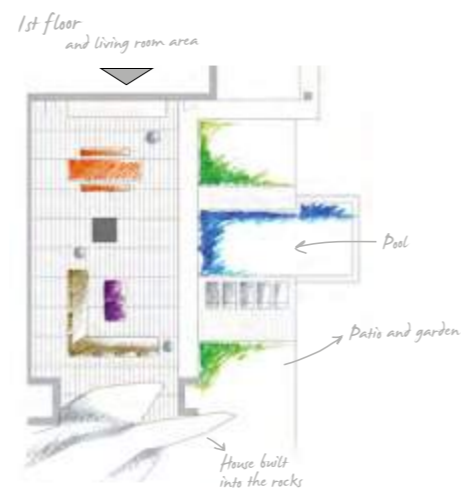

atlas concorde



atlas concorde

INDEX

OVERVIEW

SPACES

RANGE

TECH. SPECS



## Private Villa, Perth

Etic Essences: Noce 11x90, Noce Strutturato 22,5x90  
 Floor installation: Straightforward installation



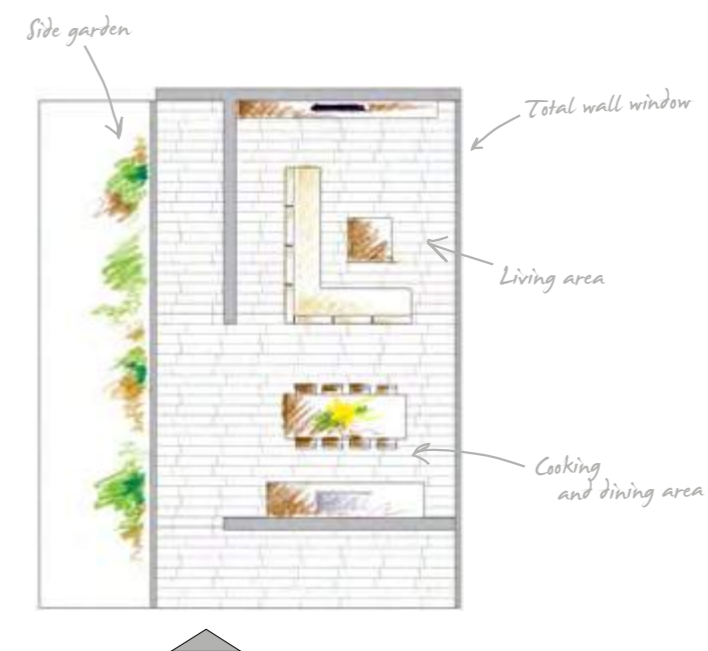

## ■ Seaside house, Rodi

Etic Essences: Rovere 15x90, Rovere Strutturato 22,5x90

Floor installation: Straightforward installation

### Continuity between outdoors and indoors

The soft luminosity of Rovere, the most classic wood essence for floors, proclaims itself as the perfect decoration finishing for residential spaces where natural light becomes an essential part of architecture environment. The two surfaces finishes, matte and textured, allow for co-ordinated projects with a continuous effect on indoor and outdoor surfaces.

### Esterni ed interni in continuità

La discreta luminosità del Rovere, la più classica delle essenze da pavimento, si rivela una perfetta finitura d'arredo negli spazi residenziali in cui la luce naturale diventa parte essenziale del contesto architettonico. Le due finiture superficiali, matt e strutturata consentono di realizzare progetti coordinati senza soluzione di continuità tra dentro e fuori.



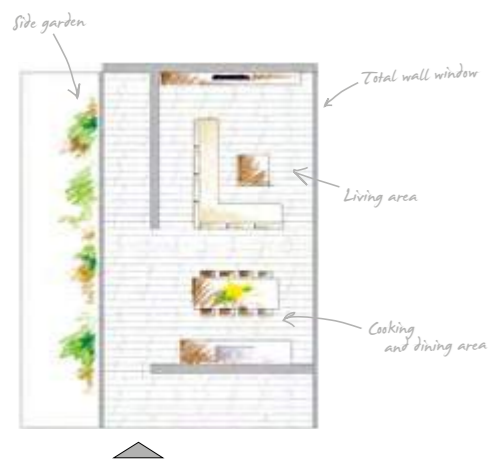

■ Seaside house, Rodi

Etic Essences: Rovere 15x90, Rovere Strutturato 22,5x90  
 Floor installation: Straightforward installation





## ■ Seaside house, Rodi

Etic Essences: Rovere 15x90,  
Rovere Strutturato 22,5x90  
Floor installation: Straightforward installation

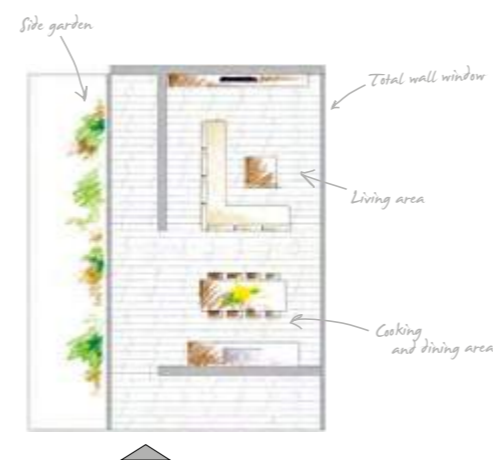

### La continuité entre extérieur et intérieur.

La luminosité discrète de Rovere, la plus classique des essences de plancher, se révèle une finition parfaite pour décorer les espaces résidentiels où la lumière naturelle devient une partie essentielle du contexte architectural. mate, douce et raffinée, ou structurée avec des qualités techniques excellentes, les deux finitions de surface permettent de concrétiser des projets coordonnés sans raccord entre intérieur et extérieur.

### Außen – und Innenbereiche in Kontinuität.

Die diffuse Leuchtkraft von Rovere die klassischste unter den Bodenessenzen, entpuppt sich als perfektes Einrichtungsfinish für Wohnräume, in denen natürliches Licht zu einem wesentlichen Bestandteil des architektonischen Kontextes wird. Die beiden Oberflächenfinishs matt und strukturiert erlauben die Realisierung von aufeinander abgestimmten Projekten ohne die Kontinuität zwischen Innen und Außen aufzulösen.

### Exteriores e interiores con continuidad.

La luminosidad tenue del Rovere, la más clásica de las maderas de pavimento, se revela un perfecto acabado de decoración en los espacios residenciales en que la luz natural se vuelve parte esencial del contexto arquitectónico. Los dos acabados superficiales, mate y estructurado permiten realizar proyectos coordinados sin separaciones entre los interiores y exteriores.

### Интерьеры и экстерьеры как цельное единство.

Умеренная яркость фактуры Rovere, воспроизводящей вид наиболее традиционной для устройства полов дубовой древесины, идеальна для оформления домашних контекстов, в которых натуральному свету отводится роль существенного элемента дизайна. Два варианта поверхности, матовый и структурный, дают возможность гармонично оформить интерьеры и экстерьеры в едином стиле.



atlas concorde

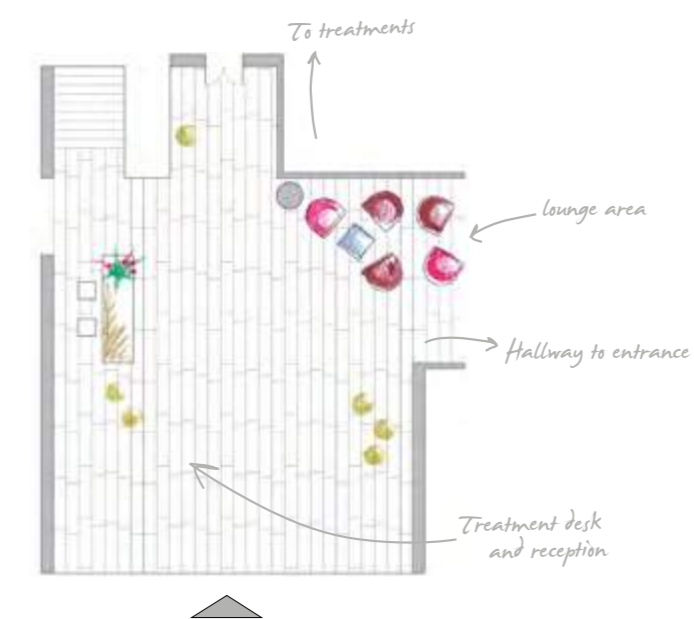

## ■ Golf Resort, Tuscany

Etic Essences: Ulivo 22,5x90 / 15x90, Ulivo Tatami 22,5x90

Floor installation: Straightforward installation

### Sensations of genuineness and value

Authentic value, natural suggestions, Mediterranean scent: all emotions evoked by the Ulivo, a valued wood with an unprecedented and seductive hue and bold contrast of knots and veining, faithfully reproduced on the ceramic surface ensuring excellent technical qualities at the same time. The mosaic Tatami becomes a precious furnishing element to clad with style architectural projects.

### Sensazioni di autenticità e valore

Valore autentico, suggestione naturale, profumo mediterraneo: sono le emozioni che evoca l'Ulivo, legno pregiato dalla cromia insolita e seducente e dal marcato contrasto di nodi e vene, che la superficie ceramica riproduce con assoluta fedeltà, assicurando qualità tecniche eccellenti. Il mosaico Tatami diventa preziosa finitura d'arredo per rivestire con stile i volumi architettonici.



atlas concorde

### ■ Golf Resort, Tuscany

Etic Essences: Ulivo 22,5x90 / 15x90, Ulivo Tatami 22,5x90  
Floor installation: Straightforward installation

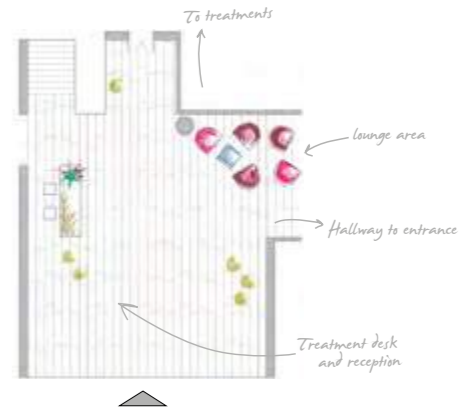

atlas concorde



#### Des sensations d'authenticité et de valeur.

Une valeur authentique, une suggestion naturelle, le parfum de la Méditerranée : ce sont les émotions suscitées par Ulivo, une essence précieuse d'une couleur insolite et séduisante, avec des veines et des nœuds bien marqués que la surface de la céramique reproduit avec une fidélité absolue tout en garantissant d'excellentes qualités techniques. La mosaïque Tatami devient une finition de décoration précieuse pour habiller avec style les volumes d'architecture.

#### Eindrücke von Authentizität und Wert.

Authentische Werte, natürlicher Reiz, mediterraner Touch: das sind Eindrücke, die Ulivo hervorruft. Ein hochwertiges Holz von ungewöhnlicher und verführerischer Farbe mit ausgeprägtem Kontrast der Knoten und Äderungen, das von der keramische Oberfläche äußerst naturgetreu reproduziert wird und die gleichzeitig hervorragende technische Eigenschaften gewährleistet. Das Mosaik Tatami wird zum kostbaren Einrichtungsfinish, um architektonische Räume zu gestalten.

#### Sensaciones de autenticidad y valor.

Valor auténtico, sugestión natural, perfume mediterráneo: son las emociones que evoca Ulivo, madera preciosa de tonalidad insólita y seductora y de un marcado contraste de nudos y venas que la superficie cerámica reproduce con absoluta fidelidad, garantizando características técnicas excelentes. El mosaico Tatami se convierte en precioso acabado de decoración para revestir con estilo los volúmenes arquitectónicos.

#### Ощущение подлинной ценности.

Подлинная ценность, натуральное очарование, средиземноморский аромат – вот ощущения, которые вызывает Ulivo, фактура, преданно воспроизводящая изумительный цвет и ярко выраженный контраст узлов и прожилок оливкового дерева. Великолепная эстетика плиток дополняется превосходными техническими характеристиками. Мозаика Tatami становится ценным элементом финальной отделки, придающим архитектурным объемам особую стильность.

## ■ Golf Resort, Tuscany

Etic Essences: Ulivo 22,5x90 / 15x90,  
Ulivo Tatami 22,5x90  
Floor installation: Straightforward installation

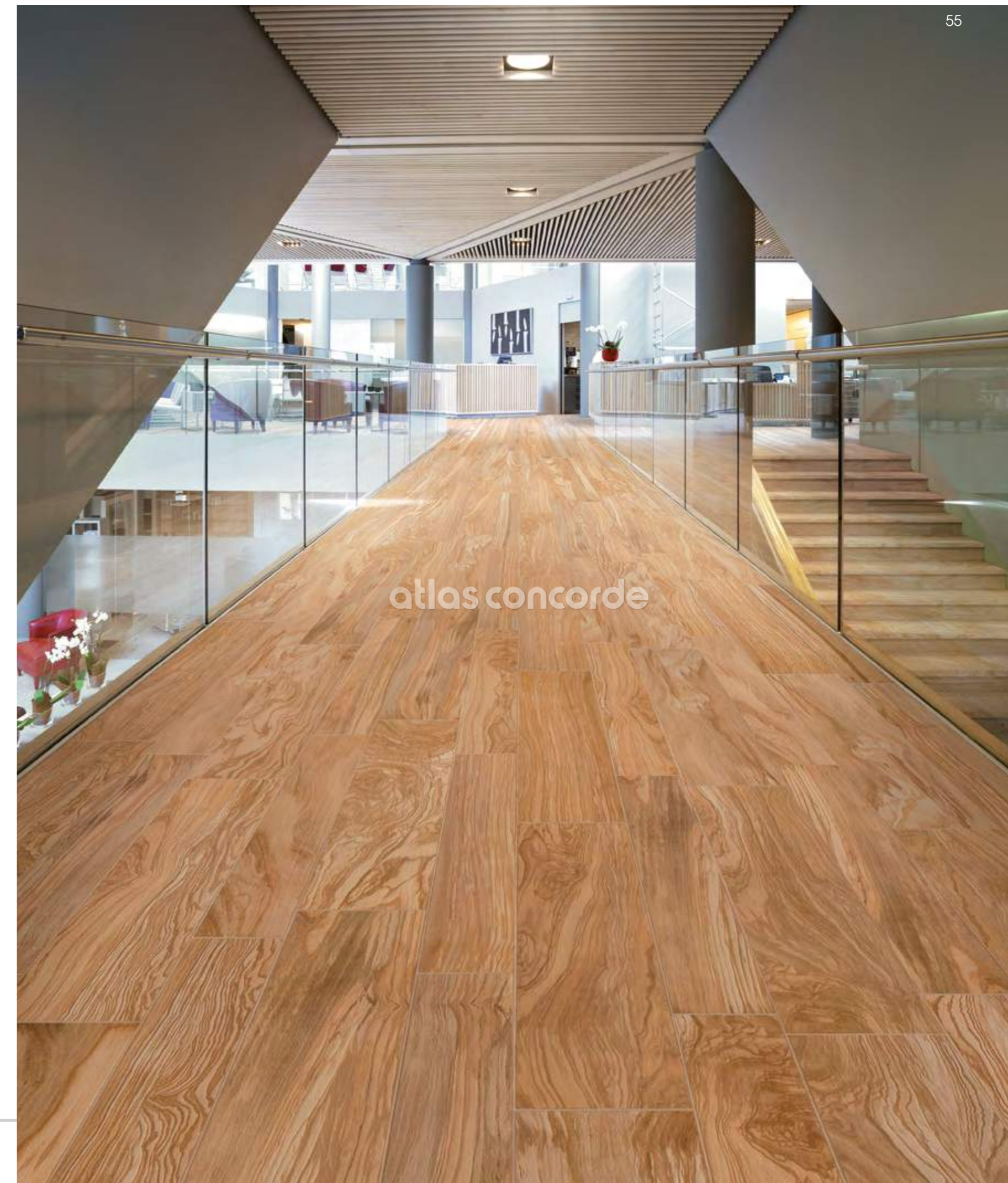
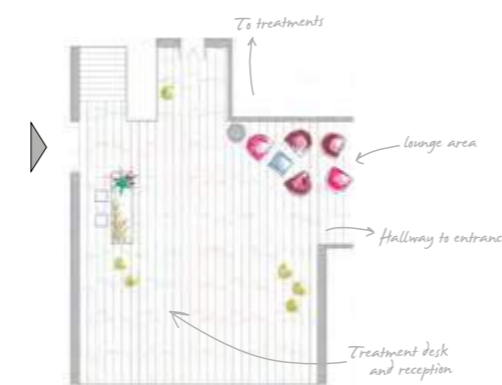



atlas concorde

Ebano

V2



atlas concorde

Rovere Grigio

V3



atlas concorde

Palissandro

V3



atlas concorde

Ulivo

V3



atlas concorde

Noce

V3



atlas concorde

Rovere Bianco

V2



atlas concorde

Rovere

V3

56 Atlas Concorde — Etic



**ETIC** 25x150 MATTE Surface  $\pm$  9 mm



**Etic Rovere 25x150**  
25x150 cm - 9<sup>7</sup>/<sub>8</sub>"x59"



**Etic Noce 25x150**  
25x150 cm - 9<sup>7</sup>/<sub>8</sub>"x59"



**Etic Palissandro 25x150**  
25x150 cm - 9<sup>7</sup>/<sub>8</sub>"x59"



**Etic Rovere Bianco 25x150**  
25x150 cm - 9<sup>7</sup>/<sub>8</sub>"x59"



**Etic Rovere Grigio 25x150**  
25x150 cm - 9<sup>7</sup>/<sub>8</sub>"x59"

## Destinations of use / Destinazioni d'uso



**MEDIUM TRAFFIC . CALPESTIO MEDIO**

MODERATE COMMERCIAL AREAS (restaurants, offices, public restrooms, public offices, hotels, business lounges, etc. save for obligated pathways) / COMMERCIALI MEDI (ristoranti, uffici, negozi, bagni pubblici, uffici pubblici, hotel, business lounge, etc. a esclusione di passaggi obbligati)

## Installation tips / Suggerimenti di posa

### 25x150 cm

In straight-forward installation patterns, it is recommended a maximum staggering of listels of 50 cm and a grout line of 1-2 mm in indoor applications. Joint-less installation is not recommended. / In posa a correre, si consiglia la sfalsatura dei listoni di massimo 50 cm e fuga di 1-2 mm in interno. È fortemente sconsigliata la posa a giunto unito. / Pour la pose à l'anglaise, nous conseillons un décalage des lames de 50 cm au maximum et un joint de 1 à 2 mm à l'intérieur. Il est absolument déconseillé de réaliser la pose avec joint nul. / Bei fortlaufender Verlegung ist es empfehlenswert die Platten maximal 50 cm versetzt und mit einer Fuge von 1-2 mm in Innenbereichen zu verlegen. Von einer fugenlosen Verlegung wird dringend abgeraten. / En colocación simple, se aconseja escalonar los listones por un máximo de 50 cm y una junta de 1-2 mm para interiores. Se desaconseja vivamente la colocación sin juntas. / При укладке вразбежку рекомендуется укладывать плитки со смещением не более 50 см и со швом 1-2 мм внутри помещений. Настоятельно не рекомендуется укладывать плитки без швов.

## Colour-shading / Stonalizzazione



V1

**Uniform appearance**  
Aspetto uniforme  
Aspect uniforme  
Gleichmäßiges  
Erscheinungsbild  
Aspecto uniforme  
Однородный вид



V2

**Slight variation**  
Variazione minima  
Variation minimale  
Leichte Abweichung  
Erscheinungsbild  
Aspecto uniforme  
Минимальная  
Неоднородность



V3

**Moderate variation**  
Variazione moderata  
Variation Modérée  
Mäßige Abweichung  
Variación moderada  
Умеренная  
Неоднородность



V4

**Substantial variation**  
Variazione sostanziale  
Variation substantielle  
Grundlegende  
Abweichung  
Variación sustancial  
Значительная  
Неоднородность

 **ETIC** 22,5x90 MATTE Surface ± 9 mm



**Etic Rovere 22,5x90** 22,5x90 cm - 8<sup>7</sup>/<sub>8</sub>"x35<sup>3</sup>/<sub>8</sub>"  
**Etic Ulivo 22,5x90** 22,5x90 cm - 8<sup>7</sup>/<sub>8</sub>"x35<sup>3</sup>/<sub>8</sub>"  
**Etic Noce 22,5x90** 22,5x90 cm - 8<sup>7</sup>/<sub>8</sub>"x35<sup>3</sup>/<sub>8</sub>"  
**Etic Palissandro 22,5x90** 22,5x90 cm - 8<sup>7</sup>/<sub>8</sub>"x35<sup>3</sup>/<sub>8</sub>"  
**Etic Rovere Bianco 22,5x90** 22,5x90 cm - 8<sup>7</sup>/<sub>8</sub>"x35<sup>3</sup>/<sub>8</sub>"  
**Etic Rovere Grigio 22,5x90** 22,5x90 cm - 8<sup>7</sup>/<sub>8</sub>"x35<sup>3</sup>/<sub>8</sub>"  
**Etic Ebano 22,5x90** 22,5x90 cm - 8<sup>7</sup>/<sub>8</sub>"x35<sup>3</sup>/<sub>8</sub>"

**22,5x90 TEXTURED Surface ± 9 mm**



**Etic Rovere 22,5x90 Strutturato** 22,5x90 cm - 8<sup>7</sup>/<sub>8</sub>"x35<sup>3</sup>/<sub>8</sub>"  
**Etic Ulivo 22,5x90 Strutturato** 22,5x90 cm - 8<sup>7</sup>/<sub>8</sub>"x35<sup>3</sup>/<sub>8</sub>"  
**Etic Noce 22,5x90 Strutturato** 22,5x90 cm - 8<sup>7</sup>/<sub>8</sub>"x35<sup>3</sup>/<sub>8</sub>"  
**Etic Palissandro 22,5x90 Strutturato** 22,5x90 cm - 8<sup>7</sup>/<sub>8</sub>"x35<sup>3</sup>/<sub>8</sub>"  
**Etic Rovere Bianco 22,5x90 Strutturato** 22,5x90 cm - 8<sup>7</sup>/<sub>8</sub>"x35<sup>3</sup>/<sub>8</sub>"  
**Etic Rovere Grigio 22,5x90 Strutturato** 22,5x90 cm - 8<sup>7</sup>/<sub>8</sub>"x35<sup>3</sup>/<sub>8</sub>"  
**Etic Ebano 22,5x90 Strutturato** 22,5x90 cm - 8<sup>7</sup>/<sub>8</sub>"x35<sup>3</sup>/<sub>8</sub>"

**22,5x90 cm - 15x90 cm - 11x90 cm**

In straight-forward installation patterns, it is recommended a maximum staggering of listels of 35 cm and a grout line of 1-2 mm in indoor applications and of 3 mm in outdoor applications. Joint-less installation is not recommended. /In posa a corriere, si consiglia la sfalsatura dei listoni di massimo 35 cm e fuga di 1- 2 mm in interno, 3 mm in esterno. È fortemente sconsigliata la posa a giunto unito. / Pour la pose à l'anglaise, nous conseillons un décalage des lames de 35 cm au maximum et un joint de 1 à 2 mm à l'intérieur, et de 3 mm à l'extérieur. Il est absolument déconseillé de réaliser la pose avec joint nul.

**15x90 MATTE Surface ± 9 mm**



**Etic Rovere 15x90** 15x90 cm - 5<sup>7</sup>/<sub>8</sub>"x35<sup>3</sup>/<sub>8</sub>"  
**Etic Ulivo 15x90** 15x90 cm - 5<sup>7</sup>/<sub>8</sub>"x35<sup>3</sup>/<sub>8</sub>"  
**Etic Noce 15x90** 15x90 cm - 5<sup>7</sup>/<sub>8</sub>"x35<sup>3</sup>/<sub>8</sub>"  
**Etic Palissandro 15x90** 15x90 cm - 5<sup>7</sup>/<sub>8</sub>"x35<sup>3</sup>/<sub>8</sub>"  
**Etic Rovere Bianco 15x90** 15x90 cm - 5<sup>7</sup>/<sub>8</sub>"x35<sup>3</sup>/<sub>8</sub>"  
**Etic Rovere Grigio 15x90** 15x90 cm - 5<sup>7</sup>/<sub>8</sub>"x35<sup>3</sup>/<sub>8</sub>"  
**Etic Ebano 15x90** 15x90 cm - 5<sup>7</sup>/<sub>8</sub>"x35<sup>3</sup>/<sub>8</sub>"

**11x90 MATTE Surface ± 9 mm**



**Etic Rovere 11x90** 11x90 cm - 4<sup>3</sup>/<sub>8</sub>"x35<sup>3</sup>/<sub>8</sub>"  
**Etic Ulivo 11x90** 11x90 cm - 4<sup>3</sup>/<sub>8</sub>"x35<sup>3</sup>/<sub>8</sub>"  
**Etic Noce 11x90** 11x90 - 4<sup>3</sup>/<sub>8</sub>"x35<sup>3</sup>/<sub>8</sub>"  
**Etic Palissandro 11x90** 11x90 cm - 4<sup>3</sup>/<sub>8</sub>"x35<sup>3</sup>/<sub>8</sub>"  
**Etic Rovere Bianco 11x90** 11x90 cm - 4<sup>3</sup>/<sub>8</sub>"x35<sup>3</sup>/<sub>8</sub>"  
**Etic Rovere Grigio 11x90** 11x90 cm - 4<sup>3</sup>/<sub>8</sub>"x35<sup>3</sup>/<sub>8</sub>"  
**Etic Ebano 11x90** 11x90 - 4<sup>3</sup>/<sub>8</sub>"x35<sup>3</sup>/<sub>8</sub>"

Bei fortlaufender Verlegung ist es empfehlenswert die Platten maximal 35 cm versetzt und mit einer Fuge von 1-2 mm in Innenbereichen bzw. 3 mm in Außenbereichen zu verlegen. Von einer fugenlosen Verlegung wird dringend abgeraten. / En colocación simple, se aconseja escalonar los listones por un máximo de 35 cm y una junta de 1- 2 mm para interiores, 3 mm para exteriores. Se desaconseja vivamente la colocación sin juntas. / При укладке вразбежку рекомендуется укладывать плитки со смещением не более 35 см и со швом 1-2 мм внутри помещений, 3 мм на улице. Настоятельно не рекомендуется укладывать плитки без швов.

# ETIC TATAMI Decor



**Etic Rovere**  
Tatami 22,5x90  
22,5x90 cm - 8<sup>7</sup>/<sub>8</sub>"x35<sup>3</sup>/<sub>8</sub>"



**Etic Ulivo**  
Tatami 22,5x90  
22,5x90 cm - 8<sup>7</sup>/<sub>8</sub>"x35<sup>3</sup>/<sub>8</sub>"



**Etic Noce**  
Tatami 22,5x90  
22,5x90 cm - 8<sup>7</sup>/<sub>8</sub>"x35<sup>3</sup>/<sub>8</sub>"



**Etic Palissandro**  
Tatami 22,5x90  
22,5x90 cm - 8<sup>7</sup>/<sub>8</sub>"x35<sup>3</sup>/<sub>8</sub>"

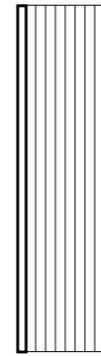

2,3x90 cm  
1<sup>7</sup>/<sub>8</sub>"x35<sup>3</sup>/<sub>8</sub>"



**Etic Rovere Bianco**  
Tatami 22,5x90  
22,5x90 cm - 8<sup>7</sup>/<sub>8</sub>"x35<sup>3</sup>/<sub>8</sub>"



**Etic Rovere Grigio**  
Tatami 22,5x90  
22,5x90 cm - 8<sup>7</sup>/<sub>8</sub>"x35<sup>3</sup>/<sub>8</sub>"



**Etic Ebano**  
Tatami 22,5x90  
22,5x90 cm - 8<sup>7</sup>/<sub>8</sub>"x35<sup>3</sup>/<sub>8</sub>"



**Metal Satin Listello 90** •  
1x90 cm - 3<sup>7</sup>/<sub>8</sub>"x35<sup>3</sup>/<sub>8</sub>"

• Metal insert. / Inserto in metallo.  
Pièce spéciale en métal. / Metall-Einleger.  
Aplicación en metal. / Вставка из металла.

# CASSETTONE&BOTTONE Decor



**Etic Rovere Cassettone 45**  
45x45 cm - 17<sup>3</sup>/<sub>4</sub>"x17<sup>3</sup>/<sub>4</sub>"



**Etic Ulivo Cassettone 45**  
45x45 cm - 17<sup>3</sup>/<sub>4</sub>"x17<sup>3</sup>/<sub>4</sub>"



**Etic Noce Cassettone 45**  
45x45 cm - 17<sup>3</sup>/<sub>4</sub>"x17<sup>3</sup>/<sub>4</sub>"



**Etic Palissandro Cassettone 45**  
45x45 cm - 17<sup>3</sup>/<sub>4</sub>"x17<sup>3</sup>/<sub>4</sub>"

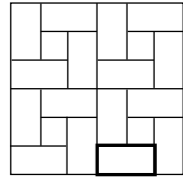

14,5x7,4 cm  
5<sup>3</sup>/<sub>4</sub>"x2<sup>7</sup>/<sub>8</sub>"



**Etic Rovere Bianco Cassettone 45**  
45x45 cm - 17<sup>3</sup>/<sub>4</sub>"x17<sup>3</sup>/<sub>4</sub>"



**Etic Rovere Grigio Cassettone 45**  
45x45 cm - 17<sup>3</sup>/<sub>4</sub>"x17<sup>3</sup>/<sub>4</sub>"



**Etic Ebano Cassettone 45**  
45x45 cm - 17<sup>3</sup>/<sub>4</sub>"x17<sup>3</sup>/<sub>4</sub>"



**Etic Rovere Bottone 7x7**  
7x7 cm - 2<sup>3</sup>/<sub>4</sub>"x2<sup>3</sup>/<sub>4</sub>"



**Etic Noce Bottone 7x7**  
7x7 cm - 2<sup>3</sup>/<sub>4</sub>"x2<sup>3</sup>/<sub>4</sub>"



**Etic Palissandro Bottone 7x7**  
7x7 cm - 2<sup>3</sup>/<sub>4</sub>"x2<sup>3</sup>/<sub>4</sub>"



**Etic Ulivo Bottone 7x7**  
7x7 cm - 2<sup>3</sup>/<sub>4</sub>"x2<sup>3</sup>/<sub>4</sub>"



**Etic Rovere Bianco Bottone 7x7**  
7x7 cm - 2<sup>3</sup>/<sub>4</sub>"x2<sup>3</sup>/<sub>4</sub>"



**Etic Rovere Grigio Bottone 7x7**  
7x7 cm - 2<sup>3</sup>/<sub>4</sub>"x2<sup>3</sup>/<sub>4</sub>"



**Etic Ebano Bottone 7x7**  
7x7 cm - 2<sup>3</sup>/<sub>4</sub>"x2<sup>3</sup>/<sub>4</sub>"



atlas concorde





## Colour-shading / Stonalizzazione



V1

### Uniform appearance

Aspetto uniforme / Aspect uniforme  
Gleichmäßiges Erscheinungsbild  
Aspecto uniforme / Однородный вид



V2

### Slight variation

Variazione minima / Variation minimale  
Leichte Abweichung / Variación mínima  
Минимальная Неоднородность



V3

### Moderate variation

Variazione moderata / Variation Modérée  
Mäßige Abweichung / Variación moderada  
Умеренная Неоднородность



V4

### Substantial variation

Variazione sostanziale / Variation substantielle  
Grundlegende Abweichung / Variación sustancial  
Значительная Неоднородность

## Destinations of use / Destinazioni d'uso

### GRIP & LASTRA 20MM SURFACE



#### HEAVY TRAFFIC . CALPESTIO PESANTE

HEAVY COMMERCIAL AREAS (malls, airports, places of worship, schools, museums, squares, hospitals, etc.) / COMMERCIALI PESANTI (mall, aeroporti, luoghi di culto, scuole, musei, piazze, ospedali etc.)

### MATTE & POLISHED SURFACE



#### MEDIUM TRAFFIC . CALPESTIO MEDIO

MODERATE COMMERCIAL AREAS (restaurants, offices, public restrooms, public offices, hotels, business lounges, etc. save for obligated pathways) / COMMERCIALI MEDI (ristoranti, uffici, negozi, bagni pubblici, uffici pubblici, hotel, business lounge, etc. a esclusione di passaggi obbligati)



**ETIC** <sup>Pro</sup>

25x150 MATTE Surface ± 9 mm



Eitic Rovere Venice 25x150  
25x150 cm - 9 7/8" x 59"



Eitic Noce Hickory 25x150  
25x150 cm - 9 7/8" x 59"



Eitic Quercia Antique 25x150  
25x150 cm - 9 7/8" x 59"



Eitic Eucalipto Smoked 25x150  
25x150 cm - 9 7/8" x 59"

## Installation tips / Suggestimenti di posa

### 25x150 cm

In straight-forward installation patterns, it is recommended a maximum staggering of listels of 50 cm and a grout line of 1-2 mm in indoor applications. Joint-less installation is not recommended. / In posa a correre, si consiglia la sfalsatura dei listoni di massimo 50 cm e fuga di 1-2 mm in interno. È fortemente sconsigliata la posa a giunto unito. / Pour la pose à l'anglaise, nous conseillons un décalage des lames de 50 cm au maximum et un joint de 1 à 2 mm à l'intérieur. Il est absolument déconseillé de réaliser la pose avec joint nul. / Bei fortlaufender Verlegung ist es empfehlenswert die Platten maximal 50 cm versetzt und mit einer Fuge von 1-2 mm in Innenbereichen zu verlegen. Von einer fugenlosen Verlegung wird dringend abgeraten. / En colocación simple, se aconseja escalonar los listones por un máximo de 50 cm y una junta de 1-2 mm para interiores. Se desaconseja vivamente la colocación sin juntas. / При укладке вразбежку рекомендуется укладывать плитки со смещением не более 50 см и со швом 1-2 мм внутри помещений. Настоятельно не рекомендуется укладывать плитки без швов.

**22,5x90 MATTE Surface** ± 9 mm

**Etic Rovere Venice 22,5x90**  
 22,5x90 cm - 8<sup>7</sup>/<sub>8</sub>"x35<sup>3</sup>/<sub>8</sub>"

**Etic Noce Hickory 22,5x90**  
 22,5x90 cm - 8<sup>7</sup>/<sub>8</sub>"x35<sup>3</sup>/<sub>8</sub>"

**Etic Quercia Antique 22,5x90**  
 22,5x90 cm - 8<sup>7</sup>/<sub>8</sub>"x35<sup>3</sup>/<sub>8</sub>"

**Etic Eucalipto Smoked 22,5x90**  
 22,5x90 cm - 8<sup>7</sup>/<sub>8</sub>"x35<sup>3</sup>/<sub>8</sub>"

**15x90 MATTE Surface** ± 9 mm

**Etic Rovere Venice 15x90**  
 15x90 cm - 5<sup>7</sup>/<sub>8</sub>"x35<sup>3</sup>/<sub>8</sub>"

**Etic Noce Hickory 15x90**  
 15x90 cm - 5<sup>7</sup>/<sub>8</sub>"x35<sup>3</sup>/<sub>8</sub>"

**Etic Quercia Antique 15x90**  
 15x90 cm - 5<sup>7</sup>/<sub>8</sub>"x35<sup>3</sup>/<sub>8</sub>"

**Etic Eucalipto Smoked 15x90**  
 15x90 cm - 5<sup>7</sup>/<sub>8</sub>"x35<sup>3</sup>/<sub>8</sub>"

**22,5x90 POLISHED Surface** ± 9 mm

**Etic Rovere Venice 22,5x90 Lappato**  
 22,5x90 cm - 8<sup>7</sup>/<sub>8</sub>"x35<sup>3</sup>/<sub>8</sub>"

**Etic Noce Hickory 22,5x90 Lappato**  
 22,5x90 cm - 8<sup>7</sup>/<sub>8</sub>"x35<sup>3</sup>/<sub>8</sub>"

**Etic Quercia Antique 22,5x90 Lappato**  
 22,5x90 cm - 8<sup>7</sup>/<sub>8</sub>"x35<sup>3</sup>/<sub>8</sub>"

**Etic Eucalipto Smoked 22,5x90 Lappato**  
 22,5x90 cm - 8<sup>7</sup>/<sub>8</sub>"x35<sup>3</sup>/<sub>8</sub>"

**22,5x90 cm - 15x90 cm**

In straight-forward installation patterns, it is recommended a maximum staggering of listels of 35 cm and a grout line of 1-2 mm in indoor applications and of 3 mm in outdoor applications. Joint-less installation is not recommended. /In posa a correre, si consiglia la sfalsatura dei listoni di massimo 35 cm e fuga di 1- 2 mm in interno, 3 mm in esterno. È fortemente sconsigliata la posa a giunto unito. / Pour la pose à l'anglaise, nous conseillons un décalage des lames de 35 cm au maximum et un joint de 1 à 2 mm à l'intérieur, et de 3 mm à l'extérieur. Il est absolument déconseillé de réaliser la pose avec joint nul.

Bei fortlaufender Verlegung ist es empfehlenswert die Platten maximal 35 cm versetzt und mit einer Fuge von 1-2 mm in Innenbereichen bzw. 3 mm in Außenbereichen zu verlegen. Von einer fugenlosen Verlegung wird dringend abgeraten. / En colocación simple, se aconseja escalonar los listones por un máximo de 35 cm y una junta de 1- 2 mm para interiores, 3 mm para exteriores. Se desaconseja vivamente la colocación sin juntas. / При укладке вразбежку рекомендуется укладывать плитки со смещением не более 35 см и со швом 1-2 мм внутри помещений, 3 мм на улице. Настоятельно не рекомендуется укладывать плитки без швов.



**Etic Rovere Venice**  
22,5x90 Grip  
22,5x90 cm - 8<sup>7</sup>/<sub>8</sub>"x35<sup>3</sup>/<sub>8</sub>"



**Etic Noce Hickory**  
22,5x90 Grip  
22,5x90 cm - 8<sup>7</sup>/<sub>8</sub>"x35<sup>3</sup>/<sub>8</sub>"



**Etic Quercia Antique**  
22,5x90 Grip  
22,5x90 cm - 8<sup>7</sup>/<sub>8</sub>"x35<sup>3</sup>/<sub>8</sub>"



**Etic Eucalipto Smoked**  
22,5x90 Grip  
22,5x90 cm - 8<sup>7</sup>/<sub>8</sub>"x35<sup>3</sup>/<sub>8</sub>"



**Etic Rovere Venice LASTRA 20mm**  
30x120 cm - 11<sup>3</sup>/<sub>4</sub>"x47<sup>1</sup>/<sub>4</sub>"



**Etic Noce Hickory LASTRA 20mm**  
30x120 cm - 11<sup>3</sup>/<sub>4</sub>"x47<sup>1</sup>/<sub>4</sub>"



**Etic Quercia Antique LASTRA 20mm**  
30x120 cm - 11<sup>3</sup>/<sub>4</sub>"x47<sup>1</sup>/<sub>4</sub>"



**Etic Eucalipto Smoked LASTRA 20mm**  
30x120 cm - 11<sup>3</sup>/<sub>4</sub>"x47<sup>1</sup>/<sub>4</sub>"



**Etic Rovere Venice LASTRA 20mm**  
60x60 cm - 23<sup>5</sup>/<sub>8</sub>"x23<sup>5</sup>/<sub>8</sub>"

## Installation tips / Suggerimenti di posa

### LASTRA 20mm

For further details on the 20 mm product, relevant trims and the installation systems, in particular for recommendations, restrictions of use, and precautions during installation, please refer to the LASTRA 20mm section on the Atlas Concorde website or to the LASTRA 20mm catalogue. / Per dettagli sul prodotto e sui relativi pezzi speciali in 20 mm di spessore, per i sistemi di posa ed, in particolare, per raccomandazioni, accorgimenti, limitazioni di utilizzo e precauzioni in fase di posa, si raccomanda di prendere visione del catalogo LASTRA 20mm e della sezione LASTRA 20mm del sito Atlas Concorde. / Pour de plus amples détails sur les produits et les pièces spéciales de 20 mm d'épaisseur et sur leurs systèmes de pose, et en particulier, pour les recommandations, mises à jour, limitations d'usage et précautions en phase de pose, veuillez prendre connaissance du catalogue LASTRA 20mm et du site Atlas Concorde LASTRA 20mm. / Für details zum produkt und formteile mit 20 mm stärke und entsprechende verlegesysteme, insbesondere hinsichtlich hinweise und anmerkungen, nutzungseinschränkungen und vorsichtsmassnahmen während der verlegung, wird die einsicht des katalogs lastra 20mm und der webseite atlas concorde lastra 20mm empfohlen. / Para más detalles sobre el producto y sus piezas especiales de 20 mm de espesor, para los sistemas de colocación y, en especial, para recomendaciones, límites de uso y precauciones en fase de colocación, aconsejamos consultar el catálogo LASTRA 20mm y la sección LASTRA 20mm del sitio Atlas Concorde. / Подробнее о плитках специальных элементах толщиной 20 мм, о системах монтажа, об ограничениях в применении, о мерах предосторожности при укладке можно узнать в каталоге LASTRA 20mm и в разделе LASTRA 20mm на сайте Atlas Concorde.

# ETIC <sup>Pro</sup> TATAMI Decor



**Etic Rovere Venice Tatami**  
22,5x90 cm - 8<sup>7</sup>/<sub>8</sub>"x35<sup>3</sup>/<sub>8</sub>"



**Etic Noce Hickory Tatami**  
22,5x90 cm - 8<sup>7</sup>/<sub>8</sub>"x35<sup>3</sup>/<sub>8</sub>"



**Etic Quercia Antique Tatami**  
22,5x90 cm - 8<sup>7</sup>/<sub>8</sub>"x35<sup>3</sup>/<sub>8</sub>"



**Etic Eucalipto Smoked Tatami**  
22,5x90 cm - 8<sup>7</sup>/<sub>8</sub>"x35<sup>3</sup>/<sub>8</sub>"

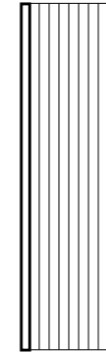

2,3x90 cm  
1<sup>1</sup>/<sub>8</sub>"x35<sup>3</sup>/<sub>8</sub>"

## CHEVRON TATAMI Decor



**Etic Rovere Venice Chevron Tatami A+B**  
74x22,2 cm - 29<sup>1</sup>/<sub>8</sub>"x8<sup>5</sup>/<sub>8</sub>"



**Etic Noce Hickory Chevron Tatami A+B**  
74x22,2 cm - 29<sup>1</sup>/<sub>8</sub>"x8<sup>5</sup>/<sub>8</sub>"



**Etic Quercia Antique Chevron Tatami A+B**  
74x22,2 cm - 29<sup>1</sup>/<sub>8</sub>"x8<sup>5</sup>/<sub>8</sub>"



**Etic Eucalipto Smoked Chevron Tatami A+B**  
74x22,2 cm - 29<sup>1</sup>/<sub>8</sub>"x8<sup>5</sup>/<sub>8</sub>"



A 3,2 cm - 1<sup>1</sup>/<sub>4</sub>"  
B 73,8 cm - 29"  
C 2,3 cm - 1<sup>1</sup>/<sub>8</sub>"

## INDUSTRIAL 3D Decor



**Etic Rovere Venice Industrial 3D**  
44x28,5 cm - 17<sup>3</sup>/<sub>8</sub>"x11<sup>1</sup>/<sub>4</sub>"



**Etic Noce Hickory Industrial 3D**  
44x28,5 cm - 17<sup>3</sup>/<sub>8</sub>"x11<sup>1</sup>/<sub>4</sub>"



**Etic Quercia Antique Industrial 3D**  
44x28,5 cm - 17<sup>3</sup>/<sub>8</sub>"x11<sup>1</sup>/<sub>4</sub>"



**Etic Eucalipto Smoked Industrial 3D**  
44x28,5 cm - 17<sup>3</sup>/<sub>8</sub>"x11<sup>1</sup>/<sub>4</sub>"

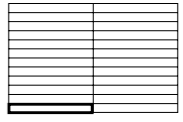

2,4x22 cm  
1"x8<sup>5</sup>/<sub>8</sub>"

## HERRINGBONE Decor



**Etic Rovere Venice Herringbone**  
36,2x41,2 cm - 14<sup>1</sup>/<sub>8</sub>"x16<sup>1</sup>/<sub>8</sub>"



**Etic Noce Hickory Herringbone**  
36,2x41,2 cm - 14<sup>1</sup>/<sub>8</sub>"x16<sup>1</sup>/<sub>8</sub>"



**Etic Quercia Antique Herringbone**  
36,2x41,2 cm - 14<sup>1</sup>/<sub>8</sub>"x16<sup>1</sup>/<sub>8</sub>"



**Etic Eucalipto Smoked Herringbone**  
36,2x41,2 cm - 14<sup>1</sup>/<sub>8</sub>"x16<sup>1</sup>/<sub>8</sub>"

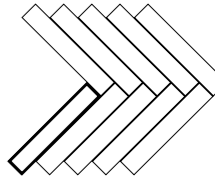

4,9x29 cm  
1<sup>7</sup>/<sub>8</sub>"x11<sup>3</sup>/<sub>8</sub>"

## CHEVRON Decor



**Etic Rovere Venice Chevron A+B**  
35x34,5 cm - 13<sup>3</sup>/<sub>4</sub>"x13<sup>3</sup>/<sub>8</sub>"



**Etic Noce Hickory Chevron A+B**  
35x34,5 cm - 13<sup>3</sup>/<sub>4</sub>"x13<sup>3</sup>/<sub>8</sub>"



**Etic Quercia Antique Chevron A+B**  
35x34,5 cm - 13<sup>3</sup>/<sub>4</sub>"x13<sup>3</sup>/<sub>8</sub>"



**Etic Eucalipto Smoked Chevron A+B**  
35x34,5 cm - 13<sup>3</sup>/<sub>4</sub>"x13<sup>3</sup>/<sub>8</sub>"

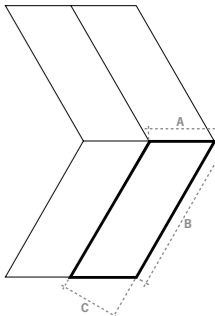

A 17 cm - 6<sup>3</sup>/<sub>4</sub>"  
B 39,8 cm - 15<sup>5</sup>/<sub>8</sub>"  
C 14,7 cm - 5<sup>7</sup>/<sub>4</sub>"

# CERAMIC AND PORCELAIN TILES: A SAFE CHOICE

## Resistance and duration

RESISTENZA E DURATA

### Easy to maintain

Facile da mantenere



Porcelain tiles do not require any special maintenance.

Il gres porcellanato non richiede manutenzioni particolari.

### UV Resistant

Resistente ai raggi UV



Porcelain tiles maintain their colors even when exposed to continuous, direct sunlight or in contact with atmospheric agents or smog.

Il gres porcellanato rimane inalterato nei suoi colori anche se esposto alla luce diretta e continua del sole o a contatto con agenti atmosferici o smog.

### Scratch resistant

Resistente al graffio



Porcelain tiles do not splinter, break or get damaged.

Il gres porcellanato non si scheggia, non si rompe e non si danneggia.

### Easy to clean

Facile da pulire



Porcelain tiles are easy to clean.

Il gres porcellanato si pulisce facilmente.

### Waterproof

Resistente all'acqua



Porcelain tiles are completely non-porous and therefore are not damaged by water or humidity.

Il gres porcellanato è completamente non poroso e non teme l'acqua e l'umidità.

## Health

SALUTE

### Zero VOCS

Zero VOC



Porcelain tiles are intrinsically inorganic and do not emit volatile organic compounds (VOC).

Le piastrelle in gres porcellanato sono intrinsecamente inorganiche e non emettono composti organici volatili.

### Zero PVC

Zero PVC



Porcelain tiles contain no PVC, plastics or petroleum derivatives.

Il gres porcellanato è privo di PVC, plastiche o derivati del petrolio.

### Zero formaldehyde

Zero formaldeide



Porcelain tiles do not contain formaldehyde.

Il gres porcellanato non contiene formaldeide.

### Stain resistant

Resistente alle macchie



Porcelain tiles are waterproof, no liquid can damage the surface.

Il gres porcellanato è impermeabile e nessun tipo di liquido può danneggiare la superficie.

### Resistant to chemicals

Resistente agli agenti chimici



Porcelain tiles do not stain and resist the most aggressive chemical agents.

Il gres porcellanato non si macchia e resiste agli agenti chimici più aggressivi.

### Resistant to acids

Resistente agli acidi



Porcelain tiles are resistant to acids found in food and cleaning products.

Il gres porcellanato resiste agli acidi di uso alimentare e domestico.

### Resistant to thermal shock

Resistente agli shock termici



A porcelain tile floor will not change as a result of sharp temperature fluctuations.

Un pavimento in gres porcellanato non si altera a causa di sbalzi termici.

### Frost resistant

Resistente al ghiaccio



Porcelain tiles are frost resistant and therefore are not damaged by low temperatures.

Il gres porcellanato è ingelivo e resiste alle temperature più basse.

### Zero allergens

Zero allergeni



Porcelain tiles are inhospitable for mites, bacteria, fungi, molds, and other irritants.

Il gres porcellanato è inospitale per acari, batteri, funghi, muffe e altre sostanze irritanti.

### Prevent bacterial growth

Previene la crescita batterica



Porcelain tiles are completely hygienic and inhospitable for bacteria, mites, molds, and fungi.

Il gres porcellanato è assolutamente igienico e inospitale per i batteri, acari, muffe e funghi.

## Safety

SICUREZZA

### Non-slip

Antiscivolo



Porcelain tile surfaces can be made with an abrasive surface grit that can increase traction and reduce the risk of slipping.

Le superfici in gres porcellanato possono essere realizzate con una graniglia abrasiva superficiale in grado di aumentare la trazione e ridurre i rischi di scivolamento.

### Fire resistant

Resistente al fuoco



Porcelain tiles are not flammable, reduce the spread of flames, do not burn, and do not emit toxic fumes.

Le piastrelle in gres porcellanato non sono infiammabili, riducono la propagazione della fiamma, non bruciano e non emettono fumi tossici.

### Heat resistant

Resistente al calore



Porcelain tiles do not change shape at high temperatures.

Il gres porcellanato non si altera alle alte temperature.

## Environment

AMBIENTE

### Energy efficiency

Efficienza energetica



The high thermal inertia of porcelain tiles moderates the changes in temperature of the rooms, favoring energy savings.

L'elevata inerzia termica del gres porcellanato modera gli sbalzi di temperatura degli ambienti, favorendo il risparmio energetico.

### Ecological

Ecologico



Porcelain tiles have a low environmental impact at all stages of their production, from the raw materials to disposal and recycling.

Il gres porcellanato ha un basso impatto ambientale in tutte le fasi del suo processo industriale, dalle materie prime fino allo smaltimento e al riciclo.

### Recycling and re-use

Riciclo e riutilizzo



Porcelain tiles are made with recycled materials, last a long time, and can be re-used because they retain their original appearance.

Il gres porcellanato è realizzato con materiali di riciclo, dura a lungo e mantenendo l'aspetto originario può essere riciclato.

### Ideal for floor heating systems

Ideale per sistemi di riscaldamento a pavimento



Porcelain tiles can be effectively combined with floor heating systems.

Il gres porcellanato può essere abbinato in modo efficace a sistemi di riscaldamento a pavimento.

## WALL TILES ADDITIONAL BENEFITS

PROPRIETÀ CERAMICA  
DA RIVESTIMENTO

### Ease of installation

Facilità di lavorazione



Cuts, holes, and bevels are easily made and reduce the time it takes to lay the white body tiles.

Tagli, fori, bisellature sono facili da realizzare e rendono più veloce la posa dei rivestimenti in pasta bianca.

### Extremely easy to clean

Estrema facilità di pulizia



White body ceramic tiles can be cleaned with a simple passage of hot water or neutral detergent.

I rivestimenti ceramici in pasta bianca si puliscono con un semplice passaggio di acqua calda o detergente neutro.

While porcelain tiles are ideal for use on the floor thanks to their hardness and extreme durability, the light weight and workability of white body tiles make them ideal for use on walls: cuts and holes can be made quickly and easily, reducing installation time and costs.

Mentre il gres porcellanato è ideale per l'uso a pavimento, per la sua durezza e l'estrema resistenza, le caratteristiche di leggerezza e lavorabilità del rivestimento in pasta bianca lo rendono ideale per l'uso a parete: i tagli e i fori saranno eseguiti facilmente e velocemente, riducendo i tempi e i costi di posa.

LE GRÈS CÉRAME : LE CHOIX SÛR / DAS FEINSTEINZEUG: EINE SICHERE WAHL / GRES PORCELÁNICO: LA ELECCIÓN SEGURA / КЕРАМИКА: НАДЕЖНЫЙ ВЫБОР

## Résistance et longévité / Widerstandsfähigkeit und Lebensdauer / Resistencia y durabilidad / Стойкость и долговечность

Résistant aux éclats thermiques

**Entretien facile / Leicht zu warten / Fácil de mantener / Простота ухода**

Le grès cérame n'exige aucun entretien particulier. / Feinsteinzeug erfordert keine besonderen Wartungsarbeiten. / El gres porcelánico no requiere particulares operaciones de mantenimiento. / Керамогранит не нуждается в особом уходе.

Résistant aux rayons UV

**Résistant aux rayons UV / UV-Strahlenfest / Resistente a los rayos UV / Стойкость к УФ-излучению**

Résistant aux rayures

Les coloris du grès cérame restent inaltérés même s'il est exposé à la lumière directe et continue du soleil ou au contact du smog et des agents atmosphériques. / Die Farben des Feinsteinzeugs bleiben unverändert erhalten, auch wenn es direktem und ständigem Sonnenlicht, der Witterung oder Smog ausgesetzt ist. / El gres porcelánico no se altera con el paso del tiempo, tampoco cambia su color cuando está expuesto a la luz directa y continua del sol o cuando entra en contacto con agentes climatológicos o contaminación. / Керамогранит не выцветает даже при постоянном воздействии солнечного света, атмосферных факторов, смога.

Résistant aux rayures

**Résistant aux rayures / Kratzfestigkeit / Resistente a las rayas / Стойкость к царапинам**

Résistant aux chocs thermiques

Le grès cérame ne subit ni ébréchures, ni cassures, ni dommages. / Feinsteinzeug splittert nicht, es zerbricht nicht und erleidet keine Beschädigungen. / El gres porcelánico no se desportilla, no se rompe y no se estropea. / Керамогранит не раскалывается, не ломается, не повреждается.

Résistant aux chocs thermiques

**Facile à nettoyer / Leicht zu reinigen / De fácil limpieza / Легкость чистки**

Résistant aux chocs thermiques

Le grès cérame se nettoie facilement. / Feinsteinzeug kann leicht gereinigt werden. / El gres porcelánico se limpia fácilmente. / Керамогранит легко очищается.

Résistant aux chocs thermiques

**Résistant aux taches / Fleckenfestigkeit / Resistente a las manchas / Стойкость к пятнам**

Résistant aux chocs thermiques

Le grès cérame est imperméable et aucun type de liquide ne peut endommager sa surface. / Feinsteinzeug ist wasserundurchlässig und Flüssigkeiten jeglicher Art können seine Oberfläche nicht beschädigen. / El gres porcelánico es impermeable y ningún tipo de líquido puede estropear la superficie. / Керамогранит непроницаем, и никакая жидкость не может повредить его поверхность.

Résistant aux chocs thermiques

**Résistant aux agents chimiques / Beständigkeit gegen chemikalien / Resistente a los agentes químicos / Стойкость к химическим веществам**

Le grès cérame ne se tache pas et résiste aux agents chimiques les plus agressifs. / Feinsteinzeug ist fleckenfest und beständig gegen die aggressivsten Chemikalien. / El gres porcelánico no se mancha y es resistente a los agentes químicos más agresivos. / Даже самые агрессивные химикаты не повреждают керамогранит и не оставляют на нем пятен.

Résistant aux chocs thermiques

**Résistant aux acides / Beständigkeit gegen säuren / Resistente a los ácidos / Стойкость к кислотам**

Résistant aux chocs thermiques

Le grès cérame résiste aux acides d'usage alimentaire et domestique. / Feinsteinzeug ist beständig gegen Säuren, die in Nahrungsmitteln oder im Haushalt verwendet werden. / El gres porcelánico es resistente a los ácidos de uso alimenticio y doméstico. / Керамогранит устойчив к кислотам, входящим в состав пищевых продуктов и средств бытовой химии.

74 Atlas Concorde — Étic

Résistant aux chocs thermiques

**Résistant aux écarts thermiques / Beständigkeit gegen thermoschocks / Resistente a los choques térmicos / Стойкость к перепадам температур**

Résistant aux chocs thermiques

Un sol en grès cérame ne subit aucune altération suite aux écarts thermiques. / Ein Feinsteinzeug-Fußboden wird von Temperaturschwankungen nicht beeinträchtigt. / El pavimento de gres porcelánico no cambia a causa de cambios bruscos de temperatura. / Напольные покрытия из керамогранита не разрушаются при перепадах температуры.

Résistant aux chocs thermiques

**Résistant à l'eau / Wasserfestigkeit / Resistente al agua / Стойкость к воде**

Résistant aux chocs thermiques

**Résistant à l'eau / Wasserfestigkeit / Resistente al agua / Стойкость к воде**

Résistant aux chocs thermiques

Le grès cérame est absolument non poreux et ne craint ni l'eau ni l'humidité. / Feinsteinzeug ist absolut porös und fürchtet weder Wasser noch Feuchtigkeit. / El gres porcelánico no es poroso, no le penetra el agua y es resistente a la humedad. / Керамогранит – абсолютно непористый материал, поэтому не боится воды и влаги.

Résistant aux chocs thermiques

**Résistant au gel / Frostbeständigkeit / Resistente a las heladas / Стойкость к морозам**

Résistant aux chocs thermiques

Le grès cérame est ingélif et résiste aux températures les plus basses. / Feinsteinzeug ist frostbeständig und widersteht den niedrigsten Temperaturen. / El gres porcelánico es resistente a las heladas y a las bajas temperaturas. / Керамогранит способен противостоять морозам и низким температурам.

Résistant aux chocs thermiques

**Résistant aux chocs thermiques**

Résistant aux chocs thermiques

**Santé / Gesundheit / Salud / Здоровье**

Résistant aux chocs thermiques

Résistant aux chocs thermiques

**Zéro allergène / Null allergene / Cero alérgenos / Ноль аллергенов**

Le grès cérame est inhospitalier vis-à-vis des acariens, bactéries, champignons, moisissures et autres substances irritantes. / Feinsteinzeug ist ungastlich für Milben, Bakterien, Pilze, Schimmel und andere Reizstoffe. / El gres porcelánico es inhóspito para los ácaros, bacterias, hongos, mohos y otras sustancias irritantes. / На поверхности керамогранита не накапливаются клещи, бактерии, грибки, плесень и другие болезнетворные микроорганизмы.

Résistant aux chocs thermiques

**Zéro COV / Null VOC / Cero VOC / Ноль летучих органических соединений**

Les carreaux en grès cérame sont intrinsèquement inorganiques et ne libèrent aucun composé organique volatil. / Feinsteinzeugfliesen sind von Natur aus anorganisch und setzen keine flüchtigen organischen Verbindungen frei. / Las baldosas de gres porcelánico son intrínsecamente inorgánicas y no emiten compuestos orgánicos volátiles. / Керамогранит является неорганическим материалом и не выделяет летучих органических соединений.

Résistant aux chocs thermiques

**Zéro formaldéhyde / Null formaldehyd / Cero formaldehído / Ноль формальдегида**

Le grès cérame ne contient pas de formaldéhyde. / Feinsteinzeug ist formaldehydfrei. / El gres porcelánico non contiene formaldehído. / Керамогранит не содержит формальдегид.

**Zéro PVC / Null PVC / Cero PVC / Ноль ПВХ**

Résistant aux chocs thermiques

Le grès cérame est privé de PVC, de matières plastiques et de dérivés du pétrole. / Feinsteinzeug ist frei von PVC, Kunststoffen oder Petroleumderivaten. / El gres porcelánico no contiene PVC, plástico o sustancias que derivan del petróleo. / Керамогранит не содержит ПВХ, пластиковых материалов, нефтепродуктов.

Résistant aux chocs thermiques

**Il prévient la croissance bactérienne / Vorbeugung gegen das wachstum von bakterien / Previene la proliferación de bacterias / Предотвращение развития бактерий**

Résistant aux chocs thermiques

Le grès cérame est absolument hygiénique et inhospitalier vis-à-vis des bactéries, acariens, moisissures et champignons. / Feinsteinzeug ist absolut hygienisch und ungastlich für Bakterien, Milben, Schimmel und Pilze. / El gres porcelánico es totalmente higiénico e inhóspito para las bacterias, ácaros, mohos y hongos. / Керамогранит абсолютно гигиеничен и препятствует развитию бактерий, клещей, плесени, грибка.

Résistant aux chocs thermiques

Résistant aux chocs thermiques

Résistant aux chocs thermiques

Résistant aux chocs thermiques

Résistant aux chocs thermiques

Résistant aux chocs thermiques

Résistant aux chocs thermiques

Résistant aux chocs thermiques

Résistant aux chocs thermiques

Résistant aux chocs thermiques

Résistant aux chocs thermiques

Résistant aux chocs thermiques

Résistant aux chocs thermiques

Résistant aux chocs thermiques

Résistant aux chocs thermiques

Résistant aux chocs thermiques

Résistant aux chocs thermiques

Résistant aux chocs thermiques

Résistant aux chocs thermiques

Résistant aux chocs thermiques

Résistant aux chocs thermiques

Résistant aux chocs thermiques

Résistant aux chocs thermiques

Résistant aux chocs thermiques

Résistant aux chocs thermiques

Résistant aux chocs thermiques

Résistant aux chocs thermiques

Résistant aux chocs thermiques

Résistant aux chocs thermiques

Résistant aux chocs thermiques

Résistant aux chocs thermiques

Résistant aux chocs thermiques

Résistant aux chocs thermiques

Résistant aux chocs thermiques

Résistant aux chocs thermiques

Résistant aux chocs thermiques

Résistant aux chocs thermiques

Résistant aux chocs thermiques

Résistant aux chocs thermiques

Résistant aux chocs thermiques

Résistant aux chocs thermiques

Résistant aux chocs thermiques

Résistant aux chocs thermiques

Résistant aux chocs thermiques

Résistant aux chocs thermiques

Résistant aux chocs thermiques

## Environnement / Umwelt / Ambiente / Окружающая среда

Résistant aux chocs thermiques

Résistant aux chocs thermiques

Résistant aux chocs thermiques

Résistant aux chocs thermiques

Résistant aux chocs thermiques

Résistant aux chocs thermiques

Résistant aux chocs thermiques

Résistant aux chocs thermiques

Résistant aux chocs thermiques

Résistant aux chocs thermiques

Résistant aux chocs thermiques

Résistant aux chocs thermiques

Résistant aux chocs thermiques

Résistant aux chocs thermiques

Résistant aux chocs thermiques

Résistant aux chocs thermiques

Résistant aux chocs thermiques

Résistant aux chocs thermiques

Résistant aux chocs thermiques

Résistant aux chocs thermiques

Résistant aux chocs thermiques

Résistant aux chocs thermiques

Résistant aux chocs thermiques

Résistant aux chocs thermiques

Résistant aux chocs thermiques

Résistant aux chocs thermiques

Résistant aux chocs thermiques

Résistant aux chocs thermiques

Résistant aux chocs thermiques

Résistant aux chocs thermiques

Résistant aux chocs thermiques

Résistant aux chocs thermiques

Résistant aux chocs thermiques

Résistant aux chocs thermiques

Résistant aux chocs thermiques

Résistant aux chocs thermiques

Résistant aux chocs thermiques

Résistant aux chocs thermiques

Résistant aux chocs thermiques

Résistant aux chocs thermiques

Résistant aux chocs thermiques

Résistant aux chocs thermiques

Résistant aux chocs thermiques

Résistant aux chocs thermiques

Résistant aux chocs thermiques

Résistant aux chocs thermiques

Résistant aux chocs thermiques

Résistant aux chocs thermiques

Résistant aux chocs thermiques

Résistant aux chocs thermiques

Résistant aux chocs thermiques

Résistant aux chocs thermiques

Résistant aux chocs thermiques

Résistant aux chocs thermiques

Résistant aux chocs thermiques

Résistant aux chocs thermiques

Résistant aux chocs thermiques

Résistant aux chocs thermiques

Résistant aux chocs thermiques

Résistant aux chocs thermiques

Résistant aux chocs thermiques

Résistant aux chocs thermiques

Résistant aux chocs thermiques

Résistant aux chocs thermiques

## PROPRIÉTÉS DE LA CÉRAMIQUE POUR REVÊTEMENTS / EIGENSCHAFTEN DER WANDFLIESEN / CARACTERÍSTICAS Y BENEFICIOS DE LA CERÁMICA PARA REVESTIMIENTO / СВОЙСТВА КЕРАМИЧЕСКОЙ ПЛИТКИ

Résistant aux chocs thermiques

Résistant aux chocs thermiques

Résistant aux chocs thermiques

Résistant aux chocs thermiques

Résistant aux chocs thermiques

Résistant aux chocs thermiques

Résistant aux chocs thermiques

Résistant aux chocs thermiques

Résistant aux chocs thermiques

Résistant aux chocs thermiques

Résistant aux chocs thermiques

Résistant aux chocs thermiques

Résistant aux chocs thermiques

Résistant aux chocs thermiques

Résistant aux chocs thermiques

Résistant aux chocs thermiques

Résistant aux chocs thermiques

Résistant aux chocs thermiques

Résistant aux chocs thermiques

Résistant aux chocs thermiques

Résistant aux chocs thermiques

Résistant aux chocs thermiques

Résistant aux chocs thermiques

Résistant aux chocs thermiques

Résistant aux chocs thermiques

Résistant aux chocs thermiques

Résistant aux chocs thermiques

Résistant aux chocs thermiques

Résistant aux chocs thermiques

Résistant aux chocs thermiques

Résistant aux chocs thermiques

Résistant aux chocs thermiques

Résistant aux chocs thermiques

Résistant aux chocs thermiques

Résistant aux chocs thermiques

Résistant aux chocs thermiques

Résistant aux chocs thermiques

Résistant aux chocs thermiques

Résistant aux chocs thermiques

Résistant aux chocs thermiques

Résistant aux chocs thermiques

Résistant aux chocs thermiques

Résistant aux chocs thermiques

Résistant aux chocs thermiques

Résistant aux chocs thermiques

Résistant aux chocs thermiques

Résistant aux chocs thermiques

Résistant aux chocs thermiques

Résistant aux chocs thermiques

Résistant aux chocs thermiques

Résistant aux chocs thermiques

Résistant aux chocs thermiques

Résistant aux chocs thermiques

Résistant aux chocs thermiques

Résistant aux chocs thermiques

Résistant aux chocs thermiques

Résistant aux chocs thermiques

Résistant aux chocs thermiques

Résistant aux chocs thermiques

Résistant aux chocs thermiques

Résistant aux chocs thermiques

Résistant aux chocs thermiques

# ETIC TRIM tiles

## INDOOR TRIM TILES

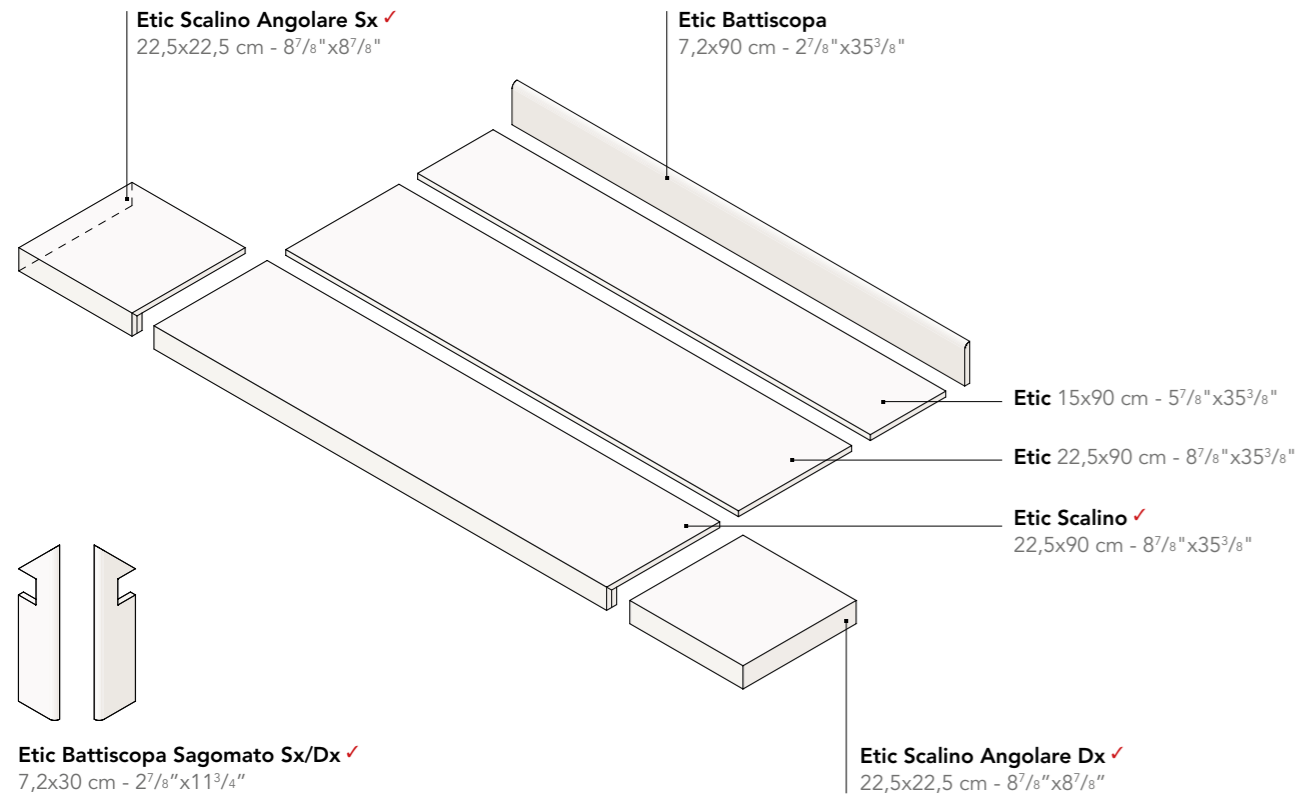

✓ These parts are supplied to order  
I pezzi sono disponibili su ordinazione  
Les pièces sont disponibles sur commande  
Die Teile sind auf Bestellung lieferbar  
Las piezas se hacen por encargo  
Изготавливаются на заказ

## NOTES / Note

For information and details relating to codes, packaging and weight it is recommended to refer to the latest pricelist / Per le informazioni e i dati relativi a codici, imballaggi e pesi occorre sempre consultare l'ultimo listino aggiornato e in vigore / Pour toutes informations et renseignements concernant les codes, les emballages et les poids, il y a toujours lieu de consulter le dernier tarif en vigueur et mis à jour / Für Informationen und Daten (Zeitgenössische Kunst) für die freundliche Zurverfügungstellung der Kunstwerke im Ambiente Art Café / Agradecemos especialmente a Betta Frigieri Arte Contemporanea por la gentil concesión de las obras del ambiente Art Café / Авторы выражают благодарность галерее Betta Frigieri Arte Contemporanea за предоставление произведений интерьера Арт-кафе.

Colours and optical features of the materials illustrated in this catalogue are to be regarded as mere indications / I colori e le caratteristiche estetiche dei materiali illustrati nel presente catalogo sono da ritenersi puramente indicativi / Les coloris et les caractéristiques esthétiques des références illustrées dans le catalogue sont données à titre purement indicatif / Die Farben und die ästhetischen Eigenschaften der in diesem Katalog abgebildeten Produkte sind als reine Richtwerte zu betrachten / Los colores y las características estéticas de los materiales ilustrados en el presente catálogo deben ser considerados como puramente indicativos / Цвета и эстетические характеристики описанных в настоящем каталоге материалов являются только ориентировочными.

Atlas Concorde reserves the right to modify any product without notice and will not be liable for any direct or indirect damage resulting from such modifications / Atlas Concorde si riserva di modificare i prodotti senza preavviso, declinando ogni responsabilità su eventuali danni diretti o indiretti derivanti da eventuali modifiche / Atlas Concorde se réserve le droit de modifier ses produits sans préavis et décline toute responsabilité concernant les éventuels dommages directs ou indirects qui pourraient dériver de ces modifications / Atlas Concorde behält sich das Recht vor jederzeit und ohne vorherige Ankündigung, die Produkte zu verändern, und lehnt jede Haftung bei direkten oder indirekten Schäden ab, die von diesen Veränderungen herrühren / Atlas Concorde se reserva el derecho de modificar los productos sin previo aviso, rechaza cualquier responsabilidad sobre eventuales daños directos o indirectos derivados de eventuales modificaciones / Atlas Concorde оставляет за собой право изменять характеристики изделий без предварительного уведомления, отклоняя при этом любую ответственность за прямые или косвенные убытки, возникшие в результате изменений.

Special thanks to the Betta Frigieri Gallery of Contemporary Art for the Art Café paintings / Si ringrazia la galleria Betta Frigieri Arte Contemporanea per la gentile concessione delle opere dell'ambiente Art Café / Nous remercions la galerie Betta Frigieri Arte Contemporanea qui nous a gentiment prêté les œuvres de l'espace Art Café / Wir danken der Galerie Betta Frigieri Arte Contemporanea (Zeitgenössische Kunst) für die freundliche Zurverfügungstellung der Kunstwerke im Ambiente Art Café / Agradecemos especialmente a Betta Frigieri Arte Contemporanea por la gentil concesión de las obras del ambiente Art Café / Авторы выражают благодарность галерее Betta Frigieri Arte Contemporanea за предоставление произведений интерьера Арт-кафе.

www.associazioneculturalebettafrigieri.it

## OUTDOOR TRIM TILES

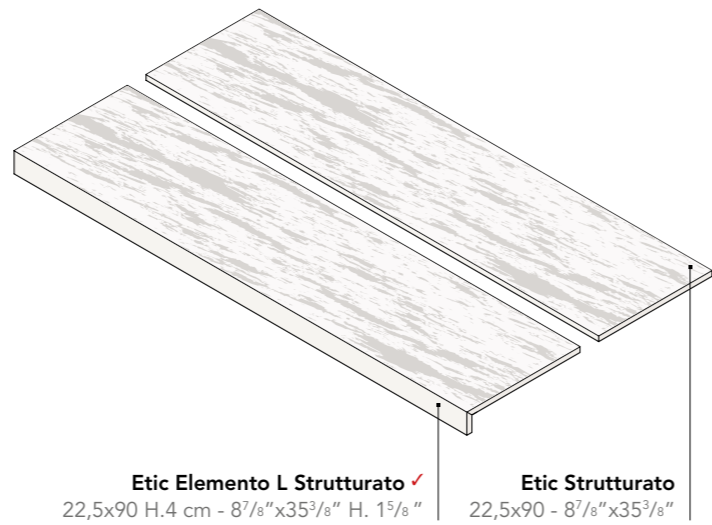

## Coloured body porcelain tiles - Rectified monocaliber

Gres porcellanato colorato in massa - Rettificato monocalibro



Compliant with standards EN 14411 annex G group Bla  
Compliant with standards ISO 13006 annex G group Bla  
Conforme alla norma EN 14411 Appendice G gruppo Bla  
Conforme alla norma ISO 13006 Appendice G gruppo Bla

25x150 cm - 9<sup>7</sup>/<sub>8</sub>"x59"  
22,5x90 cm - 8<sup>7</sup>/<sub>8</sub>"x35<sup>3</sup>/<sub>8</sub>"  
15x90 cm - 5<sup>7</sup>/<sub>8</sub>"x35<sup>3</sup>/<sub>8</sub>"  
11x90 cm - 4<sup>7</sup>/<sub>8</sub>"x35<sup>3</sup>/<sub>8</sub>"

± 9 mm  
± 9 mm  
± 9 mm  
± 9 mm

	Technical features Caratteristiche tecniche	Test Method Metodo di prova	Requirements for nominal size N / Requisiti per dimensione nominale N		
			7 cm ≤ N < 15 cm (mm)	N ≥ 15 cm (%) (mm)	
Regularity Characteristics Caratteristiche di Regolarità	Length and width Lunghezza e larghezza	ISO 10545-2	± 0,9 <sup>(1)</sup>	± 0,6 <sup>(1)</sup>	± 2,0 <sup>(1)</sup>
	Thickness Spessore		± 0,5 <sup>(**)</sup>	± 5 <sup>(**)</sup>	± 0,5 <sup>(**)</sup>
	Straightness of sides Rettilineità degli spigoli		± 0,75 <sup>(***)</sup>	± 0,5 <sup>(***)</sup>	± 1,5 <sup>(***)</sup>
	Rectangularity (Measurement only on short edges when L/l ≥ 3) Ortogonalità (Misurazione da condurre solo sui lati corti quando L/l ≥ 3)		± 0,75 <sup>(****)</sup>	± 0,5 <sup>(****)</sup>	± 2,0 <sup>(****)</sup>
	Surface flatness Planarità	ISO 10545-2	c.c. ± 0,75 e.c. ± 0,75 w. ± 0,75	c.c. ± 0,5 e.c. ± 0,5 w. ± 0,5	c.c. ± 2,0 e.c. ± 2,0 w. ± 2,0
			EN 14411 annex G (Group Bla) EN 14411 appendice G (Gruppo Bla)	ISO 13006 annex G (Group Bla) ISO 13006 appendice G (Gruppo Bla)	
Structural Characteristics Caratteristiche Strutturali	Water absorption (in% by mass) Massa d'acqua assorbita (come % della massa)	ISO 10545-3 ASTM C373	E <sub>v</sub> ≤ 0,5% Individual Maximum 0,6% E <sub>v</sub> ≤ 0,5% Valore massimo singolo 0,6%		
Bulk Mechanical Characteristics Caratteristiche Meccaniche Massive	Breaking strength Sforzo di rottura	ISO 10545-4	S ≥ 1300 N		
	Modulus of rupture Resistenza alla flessione		R ≥ 35 N/mm <sup>2</sup>		
Surface mechanical Characteristics Caratteristiche meccaniche superficiali	Impact resistance, as coefficient of restitution Resistenza all'impatto, espresso come coefficiente di restituzione	ISO 10545-5	Declared value Dichiarare un valore	Test method available Metodo di prova disponibile	
	Mohs hardness Durezza Mohs	EN 101	-		
Thermal and Igmometric Characteristics Caratteristiche Termo-Igrometriche	Resistance to deep abrasion of unglazed tiles (removed volume) Resistenza all'abrasione profonda delle piastrelle non smaltate (volume materiale asportato)	ISO 10545-6	≤ 175 mm <sup>3</sup>		
	Coefficient of thermal linear expansion Coefficiente di dilatazione termica lineare	ISO 10545-8	Declared value Dichiarare un valore	Test method available Metodo di prova disponibile	
Physical Properties Proprietà fisiche	Thermal shock resistance Resistenza agli sbalzi termici	ISO 10545-9	Pass according to EN ISO 10545-1 Test superato in accordo con ISO 10545-1	Test method available Metodo di prova disponibile	
	Moisture expansion (in mm/m) Dilatazione all'umidità (in mm/m)	ISO 10545-10	Declared value Dichiarare un valore	Test method available Metodo di prova disponibile	
	Frost resistance Resistenza al gelo	ISO 10545-12	Pass according to EN ISO 10545-1 Test superato in accordo con ISO 10545-1	Required Metodo di prova richiesto	
Chemical Characteristics Caratteristiche Chimiche	Bond strength/adhesion for improved cementitious adhesives Adesione a trazione con adesivi cementizi migliorati	EN 1348	Declared value Dichiarare un valore	-	
	Reaction to fire Reazione al fuoco	-	Class A1 or A1 <sub>fl</sub> Classe A1 oppure A1 <sub>fl</sub>	-	
Safety Characteristics Caratteristiche di sicurezza (1)(2)	Resistance to household chemicals and swimming pool salts Resistenza ai prodotti chimici di uso domestico e agli additivi per piscina	Minimum Class B (UB for unglazed tiles) Classe minima B (UB per piastrelle non smaltate)			
	Resistance to low concentrations of acids and alkalis Resistenza a basse concentrazioni di acidi e alcali	ISO 10545-13	Declared Class Dichiarare una Classe	Manufacturer is to state classification Secondo la classificazione indicata dal fabbricante	
	Resistance to high concentrations of acids and alkalis Resistenza ad alte concentrazioni di acidi e alcali		Declared Class Dichiarare una Classe	Test method available Metodo di prova disponibile	
Safety Characteristics Caratteristiche di sicurezza (1)(2)	Resistance to staining for glazed tiles Resistenza alle macchie piastrelle smaltate	ISO 10545-14	Declared Class Dichiarare una Classe	Test method available Metodo di prova disponibile	
	Barefoot Ramp Test Metodo della rampa a piedi nudi	DIN 51097 (CENTS 16165, Annex A)	Declared value Dichiarare un valore	-	
	Shod Ramp Test Metodo della rampa "calzata"	DIN 51130 (CENTS 16165, Annex B)	Declared value Dichiarare un valore	-	
Safety Characteristics Caratteristiche di sicurezza (1)(2)	Pendulum Friction Test Metodo del Pendolo	UNE-ENV 12633 (CENTS 16165, Annex C)	Declared value Dichiarare un valore	-	
	Coefficient of friction (COF) Coefficiente di attrito	B.C.R.A. Rep. CEC/81	D. M. 236/89 del 14/06/89 μ > 0,40 per elemento scivolante cuoio su pavimentazione asciutta μ > 0,40 per elemento scivolante gomma dura su pavimentazione bagnata		
	Dynamic coefficient of friction (DCOF) Coefficiente di attrito dinamico	ANSI A137.1-2012	ANSI A.137.1 Requires a minimum value of 0.42 for commercial areas that are likely to be wet.		
Safety Characteristics Caratteristiche di sicurezza (1)(2)	Static coefficient of friction (SCOF) Coefficiente di attrito statico	ASTM C1028-2007	The Ceramic Tiles Institute identifies Tile Slip Resistant when SCOF ≥ 0,60		
	Pendulum Friction Test Metodo del Pendolo	AS/NZS 4586-2013, Appendix A (Four S rubber)	Declared Classification of the pedestrian surface materials according to the Wet Pendulum Test		

<sup>(1)</sup> The permissible deviation, in % or mm, of the average size for each tile (2 or 4 sides) from work size (W). Deviazione ammissibile, in % oppure mm, della dimensione media di ogni piastrella (2 oppure 4 lati) dalla dimensione di fabbricazione (W).  
<sup>(2)</sup> The permissible deviation, in % or mm, of the average thickness for each tile from the work size thickness (W). Deviazione ammissibile, in % oppure mm, dello spessore medio di ogni piastrella dallo spessore riportato nella dimensione di fabbricazione (W).  
<sup>(\*)</sup> The maximum permissible deviation from straightness, in % or mm, related to the corresponding work sizes (W). Deviazione massima ammissibile di rettilineità, in % oppure mm, in rapporto alle dimensioni di fabbricazione (W) corrispondenti.  
<sup>(\*\*)</sup> The maximum permissible deviation from rectangularity, in % or mm, related to the corresponding work sizes (W). Deviazione massima ammissibile di ortogonalità, in % oppure mm, in rapporto alle dimensioni di fabbricazione (W) corrispondenti.  
<sup>(\*\*\*)</sup> The maximum permissible deviation from centre curvature, in % or mm, related to diagonal calculated from the work sizes (W). Deviazione massima ammissibile della curvatura del centro, in % oppure mm, in rapporto alla diagonale calcolata secondo le dimensioni di fabbricazione (W).  
<sup>(\*\*\*\*)</sup> The maximum permissible deviation from edge curvature, in % or mm, related to the corresponding work sizes (W). Deviazione massima ammissibile della curvatura dello spigolo, in % oppure mm, in rapporto alle dimensioni di fabbricazione (W) corrispondenti.  
<sup>(v)</sup> The maximum permissible deviation from warpage, in % or mm, related to diagonal calculated from the work sizes (W). Deviazione massima ammissibile dello svergolamento, in % oppure mm, in rapporto alla diagonale calcolata secondo le dimensioni di fabbricazione (W).  
(1). Anti-slip performance is guaranteed at the time of delivery of the product. Le prestazioni anti-slip vengono garantite al momento della consegna del prodotto.  
(2). Determination of slip resistance of pedestrian surfaces; it does not cover sports surfaces and road surfaces for vehicles (skid resistance). Determinazione della resistenza allo scivolamento delle superfici pedonabili; non si applica alle pavimentazioni sportive ed alle pavimentazioni stradali veicolari.  
(3). For further details, please refer to outdoor design general catalogue. Per maggiori informazioni riferirsi al catalogo generale Outdoor Design.

INDEX

OVERVIEW

SPACES

RANGE

TECH. SPECS

ETIC	
Matte	Textured
± 0,3% ± 1,0 mm	± 0,3% ± 1,0 mm
± 5,0% ± 0,5 mm	± 5,0% ± 0,5 mm
± 0,3% ± 0,8 mm	± 0,3% ± 0,8 mm
± 0,3% ± 1,5 mm	± 0,3% ± 1,5 mm
± 0,4% ± 1,8 mm	Not applicable to "strong" structures Non applicabile a strutture forti
≤ 0,1 %	≤ 0,1 %
≤ 0,5 %	≤ 0,5 %
S ≥ 1500 N	S ≥ 2000 N
R ≥ 40 N/mm <sup>2</sup>	R ≥ 45 N/mm <sup>2</sup>
≥ 0,55	≥ 0,55
7	8
≤ 150 mm <sup>3</sup>	≤ 150 mm <sup>3</sup>
≤ 7 MK <sup>-1</sup>	≤ 7 MK <sup>-1</sup>
Resistant Resiste	Resistant Resiste
≤ 0,01% (0,1mm/m)	≤ 0,01% (0,1mm/m)
Resistant Resiste	Resistant Resiste
≥ 1,0 N/mm <sup>2</sup> (Class C2 - EN 12004)	≥ 1,0 N/mm <sup>2</sup> (Class C2 - EN 12004)
A1 - A1 <sub>fl</sub>	A1 - A1 <sub>fl</sub>
UA	UA
ULA	ULA
UHA	UHA
5	5
A	A+B+C
R9	R11
Class 1	Class 3
> 0,40 Asciutto > 0,40 Bagnato	> 0,40 Asciutto > 0,40 Bagnato
> 0,42 Wet	> 0,42 Wet
≥ 0,60 Dry ≥ 0,60 Wet	≥ 0,60 Dry ≥ 0,60 Wet
-	Class P4





GREEN PROJECT

The LEED BD&C v 4 standard (LEED Building Design & Construction), effective since 31 October 2016, is a rating system dedicated to the development of “green” buildings. Developed by the US Green Building Council and internationally recognised, it outlines the necessary requirements to build eco-compatible projects, capable of functioning in a sustainable and autonomous way from an energy point of view, as well as having a low environmental impact throughout their entire life cycle. This system is based on the allocation of credits for each single requirement: the total amount of credits defines the certification level obtained. Ceramic tiles can also contribute to the achievement of LEED points. Ceramiche Atlas Concorde is a member of the US Green Building Council.

Lo standard LEED BD&C v 4 (LEED Building Design & Construction), entrato in vigore il 31 Ottobre 2016, è un sistema di rating per lo sviluppo di edifici “verdi”. Elaborato dall’US Green Building Council e riconosciuto a livello internazionale, indica i requisiti per costruire edifici eco-compatibili, capaci di funzionare in maniera sostenibile ed autosufficiente a livello energetico e di avere un basso impatto sull’ambiente durante tutto il loro ciclo di vita. Il sistema si basa sull’attribuzione di crediti per ciascuno dei requisiti: dalla somma dei crediti deriva il livello di certificazione ottenuto. Anche le piastrelle ceramiche possono contribuire al raggiungimento dei crediti LEED. Ceramiche Atlas Concorde è membro dell’US Green Building Council.

[www.usgbc.org/leed](http://www.usgbc.org/leed)

#### VOC CONTENT.

Low-emitting materials with zero emission of volatile organic compounds (VOC). It can contribute to the awarding of 1 LEED credit.

*Materiali a bassa emissione con cessione nulla di sostanze organiche volatili (VOC: “volatile organic compounds”). Può contribuire al raggiungimento di 1 credito LEED.*



#### PORCELAIN TILES COLLECTION

Outdoor products that mitigate the “heat island” phenomenon, thereby reducing effects on the microclimate, the human habitat and wildlife can contribute to earning a LEED credit.

*HEAT ISLAND EFFECT. Possono contribuire al raggiungimento di un credito Leed i prodotti che, utilizzati in esterno, mitigano il fenomeno dell’ “isola di calore” riducendo gli effetti sul microclima, sull’habitat umano e sulla fauna selvatica.*



#### BUILDING PRODUCT DISCLOSURE AND OPTIMIZATION. SOURCING OF RAW MATERIALS (MR) “RECYCLED CONTENT”.

For several porcelain stoneware items and all Light-body wall tiles, Atlas Concorde has a certificate issued by a third party that certifies the percentage of recycled “pre-consumer” material and that can therefore help earn a LEED credit.

*Per diversi articoli in grès porcellanato e tutti i rivestimenti in pasta bianca, Atlas Concorde dispone di una certificazione rilasciata da ente terzo che attesta la percentuale di materiale riciclato “pre-consumer” che può contribuire al raggiungimento di un credito LEED.*

#### MADE IN ITALY



The Made in Italy logo of Atlas Concorde stands for style, quality and ethics. Having firmly adhered to the Ethical Code promoted by Confindustria Ceramica, Atlas Concorde places the Made in Italy logo on all the products designed and produced in Italy, that is to say ceramic tiles, decorations and the majority of special trim tiles. Only a small amount of the latter is manufactured in Spain. Atlas Concorde products are produced using eco-friendly technologies, top quality and safe raw materials with the best working conditions guaranteed for our personnel. For these reasons, Atlas Concorde’s Made in Italy is the expression of strong values such as style, design, product quality, and respect for the environment and the people who live in it.

*Il marchio Made in Italy di Atlas Concorde è sinonimo di stile, qualità ed etica. Avendo aderito con convinzione al Codice Etico di Confindustria Ceramica, Atlas Concorde appone il marchio Made in Italy su tutti i prodotti studiati, progettati e realizzati in Italia, nella fattispecie tutte le piastrelle di ceramica, le decorazioni e la maggioranza dei pezzi speciali. Solo un ristretto numero di questi ultimi è fabbricato in Spagna. I prodotti Atlas Concorde sono inoltre realizzati con tecnologie rispettose dell’ambiente, utilizzando materie prime eccellenti e sicure, garantendo le migliori condizioni di lavoro. Per queste ragioni il Made in Italy di Atlas Concorde è espressione di valori forti quali stile, design, qualità del prodotto, attenzione all’ambiente e alle persone.*



The Ceramics of Italy logo is an exclusive identification on ceramic products which have effectively been made in Italy by companies that are a part of the Confindustria Ceramica and who adhered to its Ethical Code. This Code, promoted and created by Confindustria Ceramica, commits all companies to communicate, clearly and with transparency, the origin of their products.

*Il marchio Ceramics of Italy contrassegna esclusivamente i prodotti ceramici effettivamente realizzati in Italia da un’azienda associata a Confindustria Ceramica che ha sottoscritto il Codice Etico. Il Codice, redatto dalla stessa Confindustria Ceramica, impegna a comunicare con chiarezza l’origine dei prodotti.*

[www.confindustriaceramica.it](http://www.confindustriaceramica.it)

MADE IN ITALY. MADE TO EXCEL.

[www.atlasconcorde.com](http://www.atlasconcorde.com)



CERAMICHE ATLAS CONCORDE S.p.A.  
Via Canaletto 141  
41042 Spezzano di Fiorano (MO) – Italia

ATLAS CONCORDE USA, Inc.  
117 Seaboard Lane - Suite 170  
Franklin, TN 37067 - USA

ATLAS CONCORDE RUSSIA  
Business centre “Meliora Place”  
Prospekt Mira 6, 129090 Moscow – Russia

**[www.atlasconcorde.com](http://www.atlasconcorde.com)**

Copyright 2017 by Ceramiche Atlas Concorde S.p.A.  
(Spezzano di Fiorano, MO - Italy)  
Grafiche Pioppi  
November 2017